

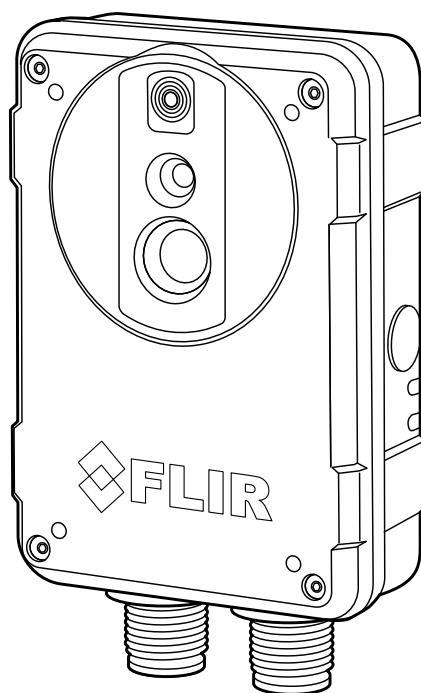

---

# User's manual FLIR AX series







**Important note**

Before operating the device, you must read, understand, and follow all instructions, warnings, cautions, and legal disclaimers.

**Důležitá poznámka**

Před použitím zařízení si přečtěte veškeré pokyny, upozornění, varování a vyvázání se ze záruky, ujistěte se, že jim rozumíte, a řiďte se jimi.

**Viktig meddelelse**

Før du betjener enheden, skal du læse, forstå og følge alle anvisninger, advarsler, sikkerhedsforanstaltninger og ansvarsfraskrivelser.

**Wichtiger Hinweis**

Bevor Sie das Gerät in Betrieb nehmen, lesen, verstehen und befolgen Sie unbedingt alle Anweisungen, Warnungen, Vorsichtshinweise und Haftungsausschlüsse

**Σημαντική σημείωση**

Πριν από τη λειτουργία της συσκευής, πρέπει να διαβάσετε, να κατανοήσετε και να ακολουθήσετε όλες τις οδηγίες, προειδοποιήσεις, προφυλάξεις και νομικές αποποιήσεις.

**Nota importante**

Antes de usar el dispositivo, debe leer, comprender y seguir toda la información sobre instrucciones, advertencias, precauciones y renunciaciones de responsabilidad.

**Tärkeä huomautus**

Ennen laitteen käyttämistä on luettava ja ymmärrettävä kaikki ohjeet, vakavat varoitukset, varoitukset ja lakitiedotteet sekä noudatettava niitä.

**Remarque importante**

Avant d'utiliser l'appareil, vous devez lire, comprendre et suivre l'ensemble des instructions, avertissements, mises en garde et clauses légales de non-responsabilité.

**Fontos megjegyzés**

Az eszköz használatá elött figyelmesen olvassa el és tartsa be az összes utasítást, figyelmeztetést, óvintézkedést és jogi nyilatkozatot.

**Nota importante**

Prima di utilizzare il dispositivo, è importante leggere, capire e seguire tutte le istruzioni, avvertenze, precauzioni ed esclusioni di responsabilità legali.

**重要な注意**

デバイスをご使用になる前に、あらゆる指示、警告、注意事項、および免責条項をお読み頂き、その内容を理解して従ってください。

**중요한 참고 사항**

장치를 작동하기 전에 반드시 다음의 사용 설명서와 경고, 주의사항, 법적 책임제한을 읽고 이해하며 따라야 합니다.

**Viktig**

Før du bruker enheten, må du lese, forstå og følge instruksjoner, advarsler og informasjon om ansvarsfraskrivelse.

**Belangrijke opmerking**

Zorg ervoor dat u, voordat u het apparaat gaat gebruiken, alle instructies, waarschuwingen en juridische informatie hebt doorgelezen en begrepen, en dat u deze opvolgt en in acht neemt.

**Ważna uwaga**

Przed rozpoczęciem korzystania z urządzenia należy koniecznie zapoznać się z wszystkimi instrukcjami, ostrzeżeniami, przestrożami i uwagami prawnymi. Należy zawsze postępować zgodnie z zaleceniami tam zawartymi.

**Nota importante**

Antes de utilizar o dispositivo, deverá proceder à leitura e compreensão de todos os avisos, precauções, instruções e isenções de responsabilidade legal e assegurar-se do seu cumprimento.

**Важное примечание**

До того, как пользоваться устройством, вам необходимо прочитать и понять все предупреждения, предостережения и юридические ограничения ответственности и следовать им.

**Viktig information**

Innan du använder enheten måste du läsa, förstå och följa alla anvisningar, varningar, försiktighetsåtgärder och ansvarsfriskrivningar.

**Önemli not**

Cihazı çalıştırmadan önce tüm talimatları, uyarıları, ikazları ve yasal açıklamaları okumalı, anlamalı ve bunlara uymalısınız.

**重要注意事項**

在操作设备之前，您必须阅读、理解并遵循所有说明、警告、注意事项和法律免责声明。

**重要注意事項**

操作裝置之前，您務必閱讀、了解並遵循所有說明、警告、注意事項與法律免責聲明。



---

# User's manual FLIR AX series





# Table of contents

---

<b>1</b>	<b>Disclaimers</b>	<b>1</b>
1.1	Legal disclaimer	1
1.2	Usage statistics	1
1.3	Changes to registry	1
1.4	U.S. Government Regulations	1
1.5	Copyright	1
1.6	Quality assurance	1
1.7	Patents	1
1.8	EULA Terms	1
1.9	EULA Terms	1
<b>2</b>	<b>Safety information</b>	<b>3</b>
<b>3</b>	<b>Notice to customer</b>	<b>4</b>
3.1	User-to-user forums	4
3.2	Calibration	4
3.3	Accuracy	4
3.4	Disposal of electronic waste	4
3.5	Training	4
3.6	Documentation updates	4
3.7	Important note about this manual	4
3.8	Note about authoritative versions	4
<b>4</b>	<b>Customer help</b>	<b>5</b>
4.1	General	5
4.2	Submitting a question	5
4.3	Downloads	6
<b>5</b>	<b>FLIR's Partner Network</b>	<b>7</b>
<b>6</b>	<b>Introduction</b>	<b>8</b>
<b>7</b>	<b>Typical system overviews</b>	<b>9</b>
<b>8</b>	<b>Quick start guide</b>	<b>11</b>
<b>9</b>	<b>List of accessories</b>	<b>12</b>
<b>10</b>	<b>Camera parts</b>	<b>13</b>
<b>11</b>	<b>Mechanical installation</b>	<b>15</b>
<b>12</b>	<b>Verifying camera operation</b>	<b>16</b>
12.1	Connecting the camera to power	16
12.2	Connecting the camera to the network	16
<b>13</b>	<b>Network-related information</b>	<b>17</b>
13.1	Troubleshooting bad connectivity	17
13.1.1	Finding the camera IP address	17
13.1.2	If you have problems connecting to the camera	17
13.1.3	Environment	17
13.1.4	Network performance issues—basic test	17
13.1.5	Network performance issues—complex test	17
13.2	Network detection	17
13.3	Unicast and multicast	18
13.4	Image streams	18
<b>14</b>	<b>Camera web server interface</b>	<b>19</b>
14.1	Supported browsers	19
14.2	Login	19
14.3	Camera tab	19
14.3.1	Working with image modes	20
14.3.2	Using the camera lamp	23
14.3.3	Flipping the video image	23
14.3.4	Calibrating the camera	25
14.3.5	Working with measurement tools	26

## Table of contents

---

14.3.6	Changing object parameters.....	29
14.3.7	Working with alarms.....	30
14.3.8	Colorizing the image.....	33
14.3.9	Adjusting the temperature scale.....	36
14.3.10	Log information.....	37
14.3.11	Camera presets.....	38
14.3.12	Pausing the live video.....	39
14.3.13	Saving a snapshot.....	40
14.3.14	Hiding the overlay graphics.....	41
14.3.15	Full screen view.....	42
14.3.16	Live image only.....	43
14.4	Settings tab.....	43
14.4.1	Camera ID.....	44
14.4.2	Regional settings.....	45
14.4.3	Network settings.....	45
14.4.4	User settings.....	46
14.4.5	Alarm recipients.....	48
14.4.6	Web interface theme.....	49
14.4.7	System.....	50
14.4.8	Firmware details.....	50
14.5	<i>Storage</i> tab.....	51
14.5.1	General.....	51
14.5.2	Managing images.....	52
14.5.3	Managing videos.....	54
<b>15</b>	<b>Software supporting FLIR AX series cameras.....</b>	<b>55</b>
<b>16</b>	<b>FLIR IP Config.....</b>	<b>56</b>
16.1	Installation.....	56
16.1.1	General information.....	56
16.1.2	System requirements.....	56
16.1.3	Installation.....	57
16.2	Detecting cameras in a network.....	57
16.2.1	General.....	57
16.2.2	Modifying IP Address settings.....	57
16.2.3	Changing the language.....	58
16.3	Program reference section.....	59
16.3.1	Main menu bar.....	59
16.3.2	Main toolbar.....	59
16.3.3	Right-click menu.....	60
16.4	Network troubleshooting.....	60
<b>17</b>	<b>Technical data.....</b>	<b>61</b>
17.1	Online field-of-view calculator.....	61
17.2	Note about technical data.....	61
17.3	Note about authoritative versions.....	61
17.4	FLIR AX8 9 Hz.....	62
<b>18</b>	<b>Minimum measurement areas.....</b>	<b>66</b>
<b>19</b>	<b>Mechanical drawings.....</b>	<b>67</b>
<b>20</b>	<b>Drilling templates.....</b>	<b>72</b>
<b>21</b>	<b>CE Declaration of conformity.....</b>	<b>75</b>
<b>22</b>	<b>Cable drawings.....</b>	<b>77</b>
<b>23</b>	<b>Pin configurations.....</b>	<b>80</b>
23.1	Pin configuration Ethernet X-coded.....	80
23.2	Pin configuration power A-coded.....	81



## Table of contents

---

<b>24</b>	<b>Digital I/O connection diagrams</b> .....	<b>82</b>
<b>25</b>	<b>Indicator LEDs and factory reset button</b> .....	<b>84</b>
25.1	Power/error indicator LED and factory reset button .....	84
25.2	Power/error indicator LED and power modes .....	84
25.3	Ethernet communication indicator LED .....	85
<b>26</b>	<b>Cleaning the camera</b> .....	<b>86</b>
26.1	Camera housing, cables, and other items .....	86
26.1.1	Liquids .....	86
26.1.2	Equipment .....	86
26.1.3	Procedure .....	86
26.2	Infrared lens .....	86
26.2.1	Liquids .....	86
26.2.2	Equipment .....	86
26.2.3	Procedure .....	86
<b>27</b>	<b>About FLIR Systems</b> .....	<b>87</b>
27.1	More than just an infrared camera .....	88
27.2	Sharing our knowledge .....	88
27.3	Supporting our customers .....	88
<b>28</b>	<b>Glossary</b> .....	<b>90</b>
<b>29</b>	<b>Thermographic measurement techniques</b> .....	<b>93</b>
29.1	Introduction .....	93
29.2	Emissivity .....	93
29.2.1	Finding the emissivity of a sample .....	93
29.3	Reflected apparent temperature .....	96
29.4	Distance .....	97
29.5	Relative humidity .....	97
29.6	Other parameters .....	97
<b>30</b>	<b>History of infrared technology</b> .....	<b>98</b>
<b>31</b>	<b>Theory of thermography</b> .....	<b>101</b>
31.1	Introduction .....	101
31.2	The electromagnetic spectrum .....	101
31.3	Blackbody radiation .....	101
31.3.1	Planck's law .....	102
31.3.2	Wien's displacement law .....	103
31.3.3	Stefan-Boltzmann's law .....	104
31.3.4	Non-blackbody emitters .....	105
31.4	Infrared semi-transparent materials .....	107
<b>32</b>	<b>The measurement formula</b> .....	<b>108</b>
<b>33</b>	<b>Emissivity tables</b> .....	<b>112</b>
33.1	References .....	112
33.2	Tables .....	112
<b>A</b>	<b>EtherNet/IP and Modbus TCP Object Models</b> .....	<b>123</b>



## 1.1 Legal disclaimer

All products manufactured by FLIR Systems are warranted against defective materials and workmanship for a period of one (1) year from the delivery date of the original purchase, provided such products have been under normal storage, use and service, and in accordance with FLIR Systems instruction.

Uncooled handheld infrared cameras manufactured by FLIR Systems are warranted against defective materials and workmanship for a period of two (2) years from the delivery date of the original purchase, provided such products have been under normal storage, use and service, and in accordance with FLIR Systems instruction, and provided that the camera has been registered within 60 days of original purchase.

Detectors for uncooled handheld infrared cameras manufactured by FLIR Systems are warranted against defective materials and workmanship for a period of ten (10) years from the delivery date of the original purchase, provided such products have been under normal storage, use and service, and in accordance with FLIR Systems instruction, and provided that the camera has been registered within 60 days of original purchase.

Products which are not manufactured by FLIR Systems but included in systems delivered by FLIR Systems to the original purchaser, carry the warranty, if any, of the particular supplier only. FLIR Systems has no responsibility whatsoever for such products.

The warranty extends only to the original purchaser and is not transferable. It is not applicable to any product which has been subjected to misuse, neglect, accident or abnormal conditions of operation. Expendable parts are excluded from the warranty.

In the case of a defect in a product covered by this warranty the product must not be further used in order to prevent additional damage. The purchaser shall promptly report any defect to FLIR Systems or this warranty will not apply.

FLIR Systems will, at its option, repair or replace any such defective product free of charge if, upon inspection, it proves to be defective in material or workmanship and provided that it is returned to FLIR Systems within the said one-year period.

FLIR Systems has no other obligation or liability for defects than those set forth above.

No other warranty is expressed or implied. FLIR Systems specifically disclaims the implied warranties of merchantability and fitness for a particular purpose.

FLIR Systems shall not be liable for any direct, indirect, special, incidental or consequential loss or damage, whether based on contract, tort or any other legal theory.

This warranty shall be governed by Swedish law.

Any dispute, controversy or claim arising out of or in connection with this warranty, shall be finally settled by arbitration in accordance with the Rules of the Arbitration Institute of the Stockholm Chamber of Commerce. The place of arbitration shall be Stockholm. The language to be used in the arbitral proceedings shall be English.

## 1.2 Usage statistics

FLIR Systems reserves the right to gather anonymous usage statistics to help maintain and improve the quality of our software and services.

## 1.3 Changes to registry

The registry entry HKEY\_LOCAL\_MACHINE\SYSTEM\CurrentControlSet\Control\Lsa\CompatibilityLevel will be automatically changed to level 2 if the FLIR Camera Monitor service detects a FLIR camera connected to the computer with a USB cable. The modification will only be executed if the camera device implements a remote network service that supports network logons.

## 1.4 U.S. Government Regulations

This product may be subject to U.S. Export Regulations. Please send any inquiries to [exportquestions@flir.com](mailto:exportquestions@flir.com).

## 1.5 Copyright

© 2016, FLIR Systems, Inc. All rights reserved worldwide. No parts of the software including source code may be reproduced, transmitted, transcribed or translated into any language or computer language in any form or by any means, electronic, magnetic, optical, manual or otherwise, without the prior written permission of FLIR Systems.

The documentation must not, in whole or part, be copied, photocopied, reproduced, translated or transmitted to any electronic medium or machine readable form without prior consent, in writing, from FLIR Systems.

Names and marks appearing on the products herein are either registered trademarks or trademarks of FLIR Systems and/or its subsidiaries. All other trademarks, trade names or company names referenced herein are used for identification only and are the property of their respective owners.

## 1.6 Quality assurance

The Quality Management System under which these products are developed and manufactured has been certified in accordance with the ISO 9001 standard.

FLIR Systems is committed to a policy of continuous development; therefore we reserve the right to make changes and improvements on any of the products without prior notice.

## 1.7 Patents

One or several of the following patents and/or design patents may apply to the products and/or features. Additional pending patents and/or pending design patents may also apply.

000279476-0001; 000439161; 000499579-0001; 000653423; 000726344; 000859020; 001106306-0001; 001707738; 001707746; 001707787; 001776519; 001954074; 002021543; 002058180; 002249953; 002531178; 0600574-8; 1144833; 1182246; 1182620; 1285345; 1299699; 1325808; 1336775; 1391114; 1402918; 1404291; 1411581; 1415075; 1421497; 1458284; 1678485; 1732314; 2106017; 2107799; 2381417; 3006596; 3006597; 466540; 483782; 484155; 4889913; 5177595; 60122153.2; 602004011681.5-08; 6707044; 68657; 7034300; 7110035; 7154093; 7157705; 7237946; 7312822; 7332716; 7336823; 7544944; 7667198; 7809258 B2; 7826736; 8,153,971; 8,823,803; 8,853,631; 8018649 B2; 8212210 B2; 8289372; 8354639 B2; 8384783; 8520970; 8565547; 8595689; 8599262; 8654239; 8680468; 8803093; D540838; D549758; D579475; D584755; D599,392; D615,113; D664,580; D664,581; D665,004; D665,440; D677298; D710,424 S; D718801; D16702302-9; D16903617-9; D17002221-6; D17002891-5; D17002892-3; D17005799-0; DM/057692; DM/061609; EP 2115696 B1; EP2315433; SE 0700240-5; US 8340414 B2; ZL 201330267619.5; ZL01823221.3; ZL01823226.4; ZL02331553.9; ZL02331554.7; ZL200480034894.0; ZL200530120994.2; ZL200610088759.5; ZL200630130114.4; ZL200730151141.4; ZL200730339504.7; ZL200820105768.8; ZL200830128581.2; ZL200880105236.4; ZL200880105769.2; ZL200930190061.9; ZL201030176127.1; ZL201030176130.3; ZL201030176157.2; ZL201030595931.3; ZL201130442354.9; ZL201230471744.3; ZL201230620731.8.











## 1.8 EULA Terms

- You have acquired a device ("INFRARED CAMERA") that includes software licensed by FLIR Systems AB from Microsoft Licensing, GP or its affiliates ("MS"). Those installed software products of MS origin, as well as associated media, printed materials, and "online" or electronic documentation ("SOFTWARE") are protected by international intellectual property laws and treaties. The SOFTWARE is licensed, not sold. All rights reserved.
- IF YOU DO NOT AGREE TO THIS END USER LICENSE AGREEMENT ("EULA"), DO NOT USE THE DEVICE OR COPY THE SOFTWARE. INSTEAD, PROMPTLY CONTACT FLIR Systems AB FOR INSTRUCTIONS ON RETURN OF THE UNUSED DEVICE(S) FOR A REFUND. ANY USE OF THE SOFTWARE, INCLUDING BUT NOT LIMITED TO USE ON THE DEVICE, WILL CONSTITUTE YOUR AGREEMENT TO THIS EULA (OR RATIFICATION OF ANY PREVIOUS CONSENT).
- GRANT OF SOFTWARE LICENSE. This EULA grants you the following license:
  - You may use the SOFTWARE only on the DEVICE.
  - NOT FAULT TOLERANT.** THE SOFTWARE IS NOT FAULT TOLERANT. FLIR Systems AB HAS INDEPENDENTLY DETERMINED HOW TO USE THE SOFTWARE IN THE DEVICE, AND MS HAS RELIED UPON FLIR Systems AB TO CONDUCT SUFFICIENT TESTING TO DETERMINE THAT THE SOFTWARE IS SUITABLE FOR SUCH USE.
  - NO WARRANTIES FOR THE SOFTWARE.** THE SOFTWARE is provided "AS IS" and with all faults. THE ENTIRE RISK AS TO SATISFACTORY QUALITY, PERFORMANCE, ACCURACY, AND EFFORT (INCLUDING LACK OF NEGLIGENCE) IS WITH YOU. ALSO, THERE IS NO WARRANTY AGAINST INTERFERENCE WITH YOUR ENJOYMENT OF THE SOFTWARE OR AGAINST INFRINGEMENT. IF YOU HAVE RECEIVED ANY WARRANTIES REGARDING THE DEVICE OR THE SOFTWARE, THOSE WARRANTIES DO NOT ORIGINATE FROM, AND ARE NOT BINDING ON, MS.
  - No Liability for Certain Damages. **EXCEPT AS PROHIBITED BY LAW, MS SHALL HAVE NO LIABILITY FOR ANY INDIRECT, SPECIAL, CONSEQUENTIAL OR INCIDENTAL DAMAGES ARISING FROM OR IN CONNECTION WITH THE USE OR PERFORMANCE OF THE SOFTWARE. THIS LIMITATION SHALL APPLY EVEN IF ANY REMEDY FAILS OF ITS ESSENTIAL PURPOSE. IN NO EVENT SHALL MS BE LIABLE FOR ANY AMOUNT IN EXCESS OF U.S. TWO HUNDRED FIFTY DOLLARS (U.S.\$250.00).**
  - Limitations on Reverse Engineering, Decompilation, and Disassembly.** You may not reverse engineer, decompile, or disassemble the SOFTWARE, except and only to the extent that such activity is expressly permitted by applicable law notwithstanding this limitation.
  - SOFTWARE TRANSFER ALLOWED BUT WITH RESTRICTIONS.** You may permanently transfer rights under this EULA only as part of a permanent sale or transfer of the Device, and only if the recipient agrees to this EULA. If the SOFTWARE is an upgrade, any transfer must also include all prior versions of the SOFTWARE.
  - EXPORT RESTRICTIONS.** You acknowledge that SOFTWARE is subject to U.S. export jurisdiction. You agree to comply with all applicable international and national laws that apply to the SOFTWARE, including the U.S. Export Administration Regulations, as well as end-user, end-use and destination restrictions issued by U.S. and other governments. For additional information see <http://www.microsoft.com/exporting/>.

## 1.9 EULA Terms

Qt4 Core and Qt4 GUI, Copyright ©2013 Nokia Corporation and FLIR Systems AB. This Qt library is a free software; you can redistribute it and/or modify it under the terms of the GNU Lesser General Public License as published by the Free Software Foundation; either version 2.1 of the License, or (at your option) any later version. This library is distributed in the hope that it will be useful, but WITHOUT ANY WARRANTY; without even the implied warranty of MERCHANTABILITY or FITNESS FOR A PARTICULAR PURPOSE. See the GNU Lesser General Public License, <http://www.gnu.org/licenses/lgpl-2.1>.

html. The source code for the libraries Qt4 Core and Qt4 GUI may be requested from FLIR Systems AB.

	<b>WARNING</b>
Make sure that you read all applicable MSDS (Material Safety Data Sheets) and warning labels on containers before you use a liquid. The liquids can be dangerous. Injury to persons can occur.	
	<b>WARNING</b>
<b>Applicability:</b> FLIR AX series.	
Do not use screws that are too long. The maximum depth of the holes in the camera is 4.5 mm (0.18"). Damage to the camera will occur if you use screws that are too long.	
	<b>CAUTION</b>
Do not point the infrared camera (with or without the lens cover) at strong energy sources, for example, devices that cause laser radiation, or the sun. This can have an unwanted effect on the accuracy of the camera. It can also cause damage to the detector in the camera.	
	<b>CAUTION</b>
Do not use the camera in temperatures more than +50°C (+122°F), unless other information is specified in the user documentation or technical data. High temperatures can cause damage to the camera.	
	<b>CAUTION</b>
Do not apply solvents or equivalent liquids to the camera, the cables, or other items. Damage to the battery and injury to persons can occur.	
	<b>CAUTION</b>
Be careful when you clean the infrared lens. The lens has an anti-reflective coating which is easily damaged. Damage to the infrared lens can occur.	
	<b>CAUTION</b>
Do not use too much force to clean the infrared lens. This can cause damage to the anti-reflective coating.	
	<b>CAUTION</b>
<b>Applicability:</b> Cameras with an automatic shutter that can be disabled.	
Do not disable the automatic shutter in the camera for a long time period (a maximum of 30 minutes is typical). If you disable the shutter for a longer time period, damage to the detector can occur.	
	<b>NOTE</b>
The encapsulation rating is only applicable when all the openings on the camera are sealed with their correct covers, hatches, or caps. This includes the compartments for data storage, batteries, and connectors.	
	<b>CAUTION</b>
Make sure that you are a minimum distance of 232 mm (10 in.) from the camera torch LED when you operate it. If you do not do this, injury to your eyes and skin can occur.	

## 3.1 User-to-user forums

Exchange ideas, problems, and infrared solutions with fellow thermographers around the world in our user-to-user forums. To go to the forums, visit:

<http://www.infraredtraining.com/community/boards/>

## 3.2 Calibration

FLIR Systems recommends that you verify your calibration yearly. You can verify the calibration yourself or with the help of a FLIR Systems Partner. If preferred, FLIR Systems offers a calibration, adjustment, and general maintenance service.

## 3.3 Accuracy

For very accurate results, we recommend that you wait 5 minutes after you have started the camera before measuring a temperature.

## 3.4 Disposal of electronic waste



As with most electronic products, this equipment must be disposed of in an environmentally friendly way, and in accordance with existing regulations for electronic waste.

Please contact your FLIR Systems representative for more details.

## 3.5 Training

To read about infrared training, visit:

- <http://www.infraredtraining.com>
- <http://www.irtraining.com>
- <http://www.irtraining.eu>

## 3.6 Documentation updates

Our manuals are updated several times per year, and we also issue product-critical notifications of changes on a regular basis.

To access the latest manuals, translations of manuals, and notifications, go to the Download tab at:

<http://support.flir.com>

It only takes a few minutes to register online. In the download area you will also find the latest releases of manuals for our other products, as well as manuals for our historical and obsolete products.

## 3.7 Important note about this manual

FLIR Systems issues generic manuals that cover several cameras within a model line.

This means that this manual may contain descriptions and explanations that do not apply to your particular camera model.

## 3.8 Note about authoritative versions

The authoritative version of this publication is English. In the event of divergences due to translation errors, the English text has precedence.

Any late changes are first implemented in English.

## FLIR Customer Support Center

Home | Answers | Ask a Question | Product Registration | Downloads | My Stuff | Service

## FLIR Customer support

Get the most out of your FLIR products

Get Support for Your FLIR Products

Welcome to the FLIR Customer Support Center. This portal will help you as a FLIR customer to get the most out of your FLIR products. The portal gives you access to:

- The FLIR Knowledgebase
- Ask our support team (requires registration)
- Software and documentation (requires registration)
- FLIR service contacts











**Find Answers**  
We store all resolved problems in our solution database. Search by product, category, keywords, or phrases.

Search by Keyword

[Search All Answers](#)

[See All Popular Answers](#)

To find a datasheet for a current product, click on a picture.  
To find a datasheet for a legacy product, click [here](#).

[FLIR Ex](#) [FLIR Exx](#) [FLIR Kxx](#) [FLIR T4xx](#) [FLIR T6xx](#) [FLIR G3xx](#)  
       
[ThermaCAM™ GasFindIR](#) [FLIR GF3xx](#) [FLIR AX](#) [FLIR Ax5](#) [FLIR A3xx](#) [More...](#)  
    

**Product catalog**  
Please right-click the links below and select Save Target As... to save the file.

 US Letter (28 Mb)  
A4 (27.4 Mb)

**Accessories**  

[Important legal disclaimer, dangers, warnings, and cautions](#)

### 4.1 General

For customer help, visit:

<http://support.flir.com>

### 4.2 Submitting a question

To submit a question to the customer help team, you must be a registered user. It only takes a few minutes to register online. If you only want to search the knowledgebase for existing questions and answers, you do not need to be a registered user.

When you want to submit a question, make sure that you have the following information to hand:

- The camera model
- The camera serial number
- The communication protocol, or method, between the camera and your device (for example, HDMI, Ethernet, USB, or FireWire)
- Device type (PC/Mac/iPhone/iPad/Android device, etc.)
- Version of any programs from FLIR Systems
- Full name, publication number, and revision number of the manual

### 4.3 Downloads

On the customer help site you can also download the following, when applicable for the product:

- Firmware updates for your infrared camera.
- Program updates for your PC/Mac software.
- Freeware and evaluation versions of PC/Mac software.
- User documentation for current, obsolete, and historical products.
- Mechanical drawings (in \*.dxf and \*.pdf format).
- Cad data models (in \*.stp format).
- Application stories.
- Technical datasheets.
- Product catalogs.



Home
Answers
Ask a Question
Product Registration
Downloads
My Stuff
Service
Partners

## Partners

**Partners network**

Welcome to our partner network.

We have established the partner network in order to support your work with marketing the FLIR products and implementing them in your customer's applications. This is the place to go to receive product information, software updates, order status etc. But this is also the place where you have a chance to suggest improvements, give product feedback or report failures.

[Ask a question](#)  
Submit a technical support question about our products and services.

[Answers](#)  
Search among our answers to find solutions to known technical issues.

[Downloads](#)  
Keep up to date with the latest FLIR software. Find manuals and up-to-date product datasheets and share the experience from others via application stories. All information can be subscribed to via rss.

[Quality reporting](#)  
Quality is important to us and we strive constantly to improve and meet your expectations. Please report out-of-the-box failures, product malfunctions or incomplete deliveries here for efficient support.

[Requesting an eRMA](#)  
If you would encounter a problem with your purchase and it has been identified by FLIR as a warranty issue, this is where you apply for the RMA number for the return of the purchase.

[Firmware updates](#)  
Find the latest firmware releases for the A-series products. As a registered partner you can subscribe to this information by RSS and will be notified when a new release is ready.

[Product feedback](#)  
As our representative you are the person closest to the market with insights of great value to us. We welcome your ideas and suggestions of product improvements, features and functions that can be of help to the customer.

[Order status](#)  
Display and search for open, partially delivered, and closed orders.

[Product bulletins](#)  
Read our external bulletins about new, changed, or discontinued products. The product bulletins also include product-critical announcements.

[Important legal disclaimer, dangers, warnings, and cautions](#)

We welcome you to join our Partner Network at our Customer Support site!

The Partner Network is located on the **Partners** tab at <http://support.flir.com> (partner registration needed) and is specifically aimed at distributors and system integrators.

Once your company has been approved, you can do one or more of the following, from a single location:

- Ask questions about a product or service.
- Search for existing answers about a product or service.
- Download manuals, software, and datasheets.
- Report quality issues.
- Request eRMAs.
- Download firmware updates.
- Send product feedback.
- See order status in SAP.
- Read product bulletins.



The FLIR AX series camera/sensor offers an affordable and accurate temperature measurement solution for anyone who needs to solve problems that require built-in “smartness” such as analysis, alarm functionality, and autonomous communication using standard protocols. The FLIR AX series camera/sensor also has all the necessary features and functions to build distributed single- or multi-camera solutions utilizing standard Ethernet hardware and software protocols.

The FLIR AX series camera/sensor also has built-in support to connect to industrial control equipment such as programmable logic controllers (PLCs), and allows the sharing of analysis and alarm results and simple control using the Ethernet/IP and Modbus TCP field bus protocols.

Key features:

- Support for the Ethernet/IP field bus protocol (analyze, alarm, and simple camera control).
- Support for the Modbus TCP field bus protocol (analyze, alarm, and simple camera control).
- Built-in analysis functionality.
- Alarm functionality, as a function of analysis and more.
- Built-in web server for control and setup.
- MJPEG/MPEG4/H.264 image streaming.
- PoE (Power over Ethernet).
- General-purpose I/O.
- 100 Mbps Ethernet (100 m cable).
- On alarm: file sending (FTP) or e-mail (SMTP) of analysis results or images.

Typical applications:

- Electrical and mechanical condition-monitoring applications where temperature or temperature trends can be an indication of a potential risk of failure.
- Simple process control applications.

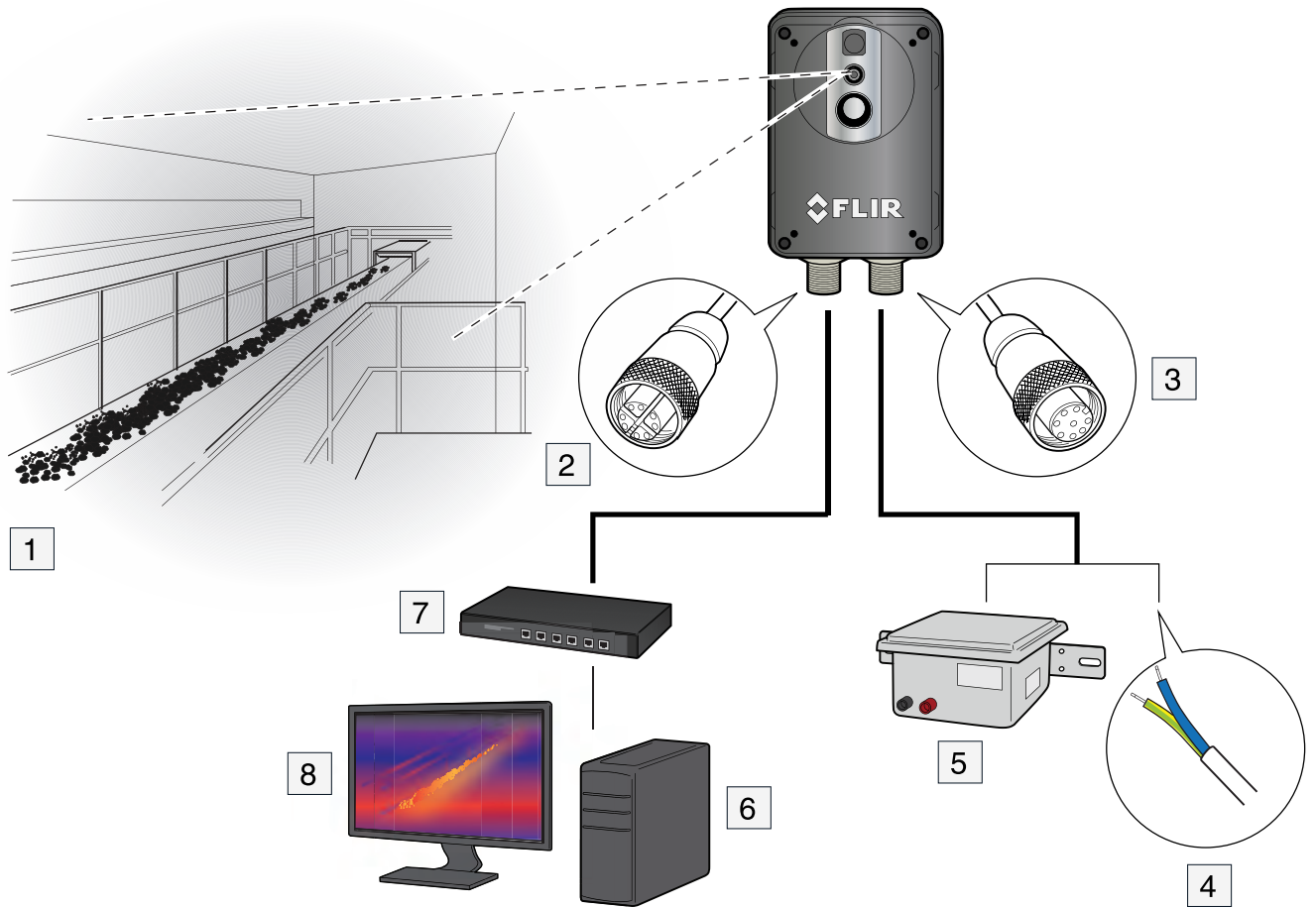

1. Coal mine conveyor belt.
2. Ethernet connector M12, X-coded.
3. Power-I/O connector M12, A-coded.
4. Digital output to a PLC.
5. Separate DIN rail power supply for galvanic isolation (10.8–30 V DC).
6. PC for the set up of the camera using the built-in web server.
7. PoE switch.
8. Infrared image on a monitor.

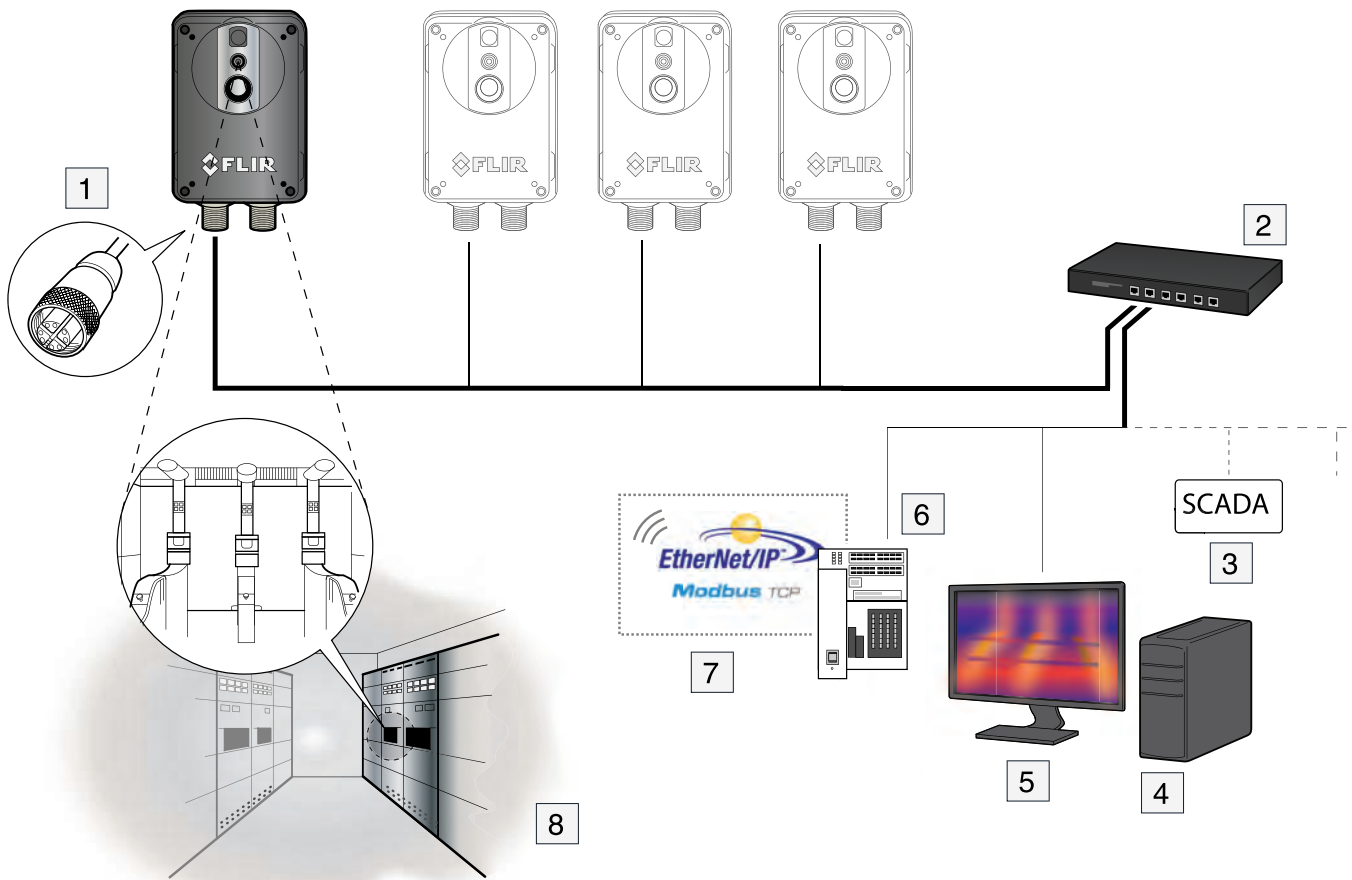

1. Ethernet connector M12, X-coded.
2. PoE switch.
3. Supervisory control and data acquisition.
4. PC for the setup of the camera using the built-in web server.
5. Infrared image on a monitor.
6. PLC.
7. Readout and analysis of data from the camera using built-in measurement functions.
8. Electrical cabinets with circuit breakers.

Follow this procedure:

1. Mount the camera.

**CAUTION**

The camera must be mounted on a cooling bracket or heat sink unless the rear side of the camera is mounted against a material with a high capacity to transfer heat, e.g., aluminum. Damage to the camera can occur if you do not do this.

2. Download FLIR IP Config from <http://tinyurl.com/o5wudd7>.
3. Install FLIR IP Config.
4. Connect the camera to power, either via a PoE injector connected to the Ethernet cable or via the power-I/O connector (10.8–30 V DC).
5. Connect the camera to the network, using the Ethernet connector.
6. Start FLIR IP Config.
7. In the main window, identify the camera and double-click it to open the camera user web.
8. Log in using the username *admin* and the password *admin*. (You can change these credentials later.)

You have now accessed the FLIR AX series user web and can set up and control the camera.

# List of accessories

---

<b>Product name</b>	<b>Part number</b>
Cable, M12 to pigtail	T128391ACC
Cooling bracket	T198821
Ethernet cable M12 to RJ45, 2 m	T128390ACC
FLIR AX8 accessory starter kit	71200-0002
Front mounting plate kit (incl. cooling bracket)	T199163
PoE injector, incl. cables	T199019
Rear mounting plate kit	T128775ACC

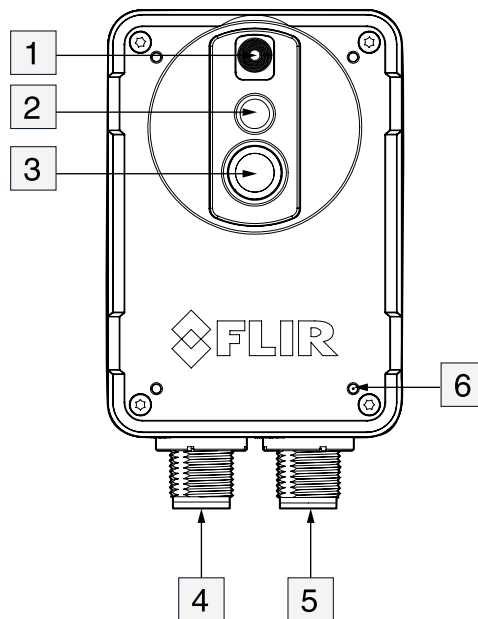

1. LED lamp.

**CAUTION**

Make sure that you are a minimum distance of 232 mm (10 in.) from the camera torch LED when you operate it. If you do not do this, injury to your eyes and skin can occur.

2. Visual camera.
3. Infrared sensor.
4. Ethernet connector, M12, X-coded.
5. Power—I/O connector, M12, A-coded.
6. Mounting holes.

See section 11 *Mechanical installation*, page 15 and section 19 *Mechanical drawings* for more information.

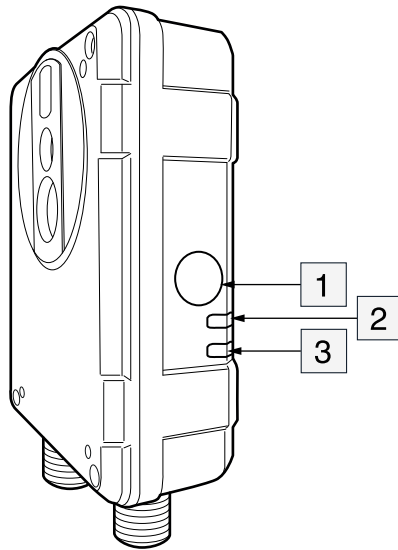

1. Factory reset button.

**Note** Do not hold down the factory reset button when connecting the camera to power.

See section 25 *Indicator LEDs and factory reset button*, page 84.

2. Ethernet communication indicator LED (green).

See section 25 *Indicator LEDs and factory reset button*, page 84.

3. Power/error indicator LED (blue/red).

See section 25 *Indicator LEDs and factory reset button*, page 84.



The camera unit has been designed to allow it to be mounted in any position. It has mounting interfaces on the front and back. For drilling templates, see section 20 *Drilling templates*, page 72.

**WARNING**

Do not use screws that are too long. The maximum depth of the holes in the camera is 4.5 mm (0.18"). Damage to the camera will occur if you use screws that are too long.

The camera generates a considerable amount of heat during operation. This is normal. In order to transfer this heat, it is recommended that the camera is mounted on a bracket or heat sink made of a material with a high capacity to transfer heat, e.g., aluminum. The use of a cooling bracket or a heat sink is also strongly recommended in order to minimize the temperature drift of the infrared detector in the camera.

A cooling bracket that has two tripod threads—one on the bottom and the other on the back—is available. This cooling bracket has a hole pattern that is compatible with third-party pan/tilt heads, e.g., the PTU-AB series from Allison Park Group, Inc.:

<http://www.apgvision.com/ptuab-series-p-108.html>

For further information regarding mounting recommendations, contact FLIR Systems.

Prior to installing the camera, use a bench test to verify camera operation and to configure the camera for the local network. The camera is configured from a web browser.

## 12.1 Connecting the camera to power

To power the camera, use one of the alternatives below:

- Connect the camera to a 10.8–30 V DC power supply using the A-coded M12 connector and cable P/N T128391ACC.
- Connect the camera to a PoE unit using the X-coded M12 connector and cable P/N T128390ACC.

See section 23 *Pin configurations*, page 80 for pin configurations.

## 12.2 Connecting the camera to the network

The camera is set up on an existing network, and an IP address is assigned from the DHCP server. The MAC address can be found on a label on the side of the camera. See the figure below.

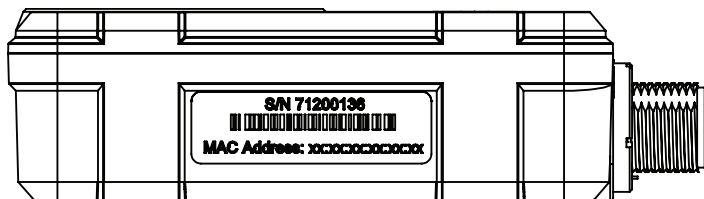

To detect the camera system on the network, use the FLIR IP Config software. You can download FLIR IP Config from the following link:

<http://tinyurl.com/o5wudd7>

**Note** The FLIR IP Config version must be 1.9 or later.

The manual for FLIR IP Config is included on the User Documentation CD-ROM that ships with the camera system. See also section 16 *FLIR IP Config*, page 56.

### 13.1 Troubleshooting bad connectivity

#### 13.1.1 Finding the camera IP address

The camera IP address can be found using FLIR IP Config, which can be downloaded at <http://tinyurl.com/o5wudd7>.

**Note** The FLIR IP Config version must be 1.9 or later.

#### 13.1.2 If you have problems connecting to the camera

Put the camera and the client on the same IP network. This ensures that there are no routing issues. Consult someone with IP knowledge if needed. The aim is for the camera to have an address of, e.g., 192.168.0.10/24 and the client an address of, e.g., 192.168.0.20/24. The /24 notation means that it is a class C network where the first three groups are fixed.

#### 13.1.3 Environment

- Make sure the camera gets the correct voltage and power. If you suspect glitches or peaks, test the camera in a controlled environment.
- If you suspect complex and strong electromagnetic fields, test the camera in a controlled office environment.

#### 13.1.4 Network performance issues—basic test

1. Ping the camera from the command line interface on the client. Ping with 300 packets (use the `-n` flag) and check that no packets are lost and that the delay (RTT) has only minor variations. The RTT should be a maximum of 10–20 ms in a small network.
2. Use managed switches so that you can check the link speed and lost packets on the camera and client ports.
3. Be careful with Wi-Fi connections and video streams. Wi-Fi can operate faultlessly, but it can also introduce a high PER (packet error rate) as well as delay and jitter.
4. Check for symptoms of lost packets: see <http://tinyurl.com/nmdx3dg> for more information.

#### 13.1.5 Network performance issues—complex test

Use a monitoring (sometimes called a mirrored or SPAN) port on the Ethernet switch. Use the Wireshark software to check the RTP (Real-time Transport Protocol) stream between the camera and the client. Record for a couple of minutes and use the RTP tools that are built in. Note that mirrored ports are not available on all switches. You need a managed switch for this functionality.

### 13.2 Network detection

FLIR AX series cameras announce themselves on a network using mDNS (multicast Domain Name System) service records. This is also known as the Bonjour service discovery protocol. The FLIR-specific service it announces is the FLIR Resource Protocol on TCP port 22136.

- Service type: `_flir-ircam._tcp`
- Service port: 22136

The associated text records are:

- ID=NCAM
- bsp=N1
- GID=Gen\_A
- SI=FFF\_RTSP
- SIV=1.0.0
- CI=RTREE
- CIV=1.0.0

Additional services that are announced are SSH (Secure Shell) and SFTP (Secure Shell File Transfer Protocol):

- Service type: `_ssh._tcp`
- Service port: 22
- Service type: `_sftp-ssh._tcp`
- Service port: 22

### 13.3 Unicast and multicast

FLIR AX series cameras support both unicast and multicast streams.

A maximum of three unicast streams (using UDP) are supported. Note that the stream shown on the user web page counts as a unicast stream.

Streaming using TCP is supported for unicast streams. TCP streaming uses port 554.

Multicast streams use the fixed multicast address 224.2.0.1. At least 16 clients can share the multicast stream.

### 13.4 Image streams

The following URLs can be used to establish streaming sessions with FLIR AX series cameras:

- `rtsp://<ip>/avc`
- `rtsp://<ip>/mpeg4`
- `rtsp://<ip>/mjpg`
- `avc` = H264 encoding with overlay graphics
- `mpeg4` = MPEG4 encoding with overlay graphics
- `mjpg` = Motion JPEG encoding with overlay graphics

If you do not want an overlay in the image stream, use the following URLs:

- `rtsp://<ip-address>/avc?overlay=off`
- `rtsp://<ip-address>/mpeg4?overlay=off`
- `rtsp://<ip-address>/mjpg?overlay=off`

The stream resolution is 640 × 480. The bitrate is set to 3 Mbit/s (default), which means that the compression factor will vary according to the color palette chosen and the scene contents.

The infrared detector has a resolution of 80 × 60, which means that the infrared image contents will be upsampled to 640 × 480.

A radiometric uncompressed 16-bit stream is not available.

## 14.1 Supported browsers

The camera web interface has been developed for and tested on Google Chrome 24 and later. Browsers supporting the latest specification (RFC 6455) of the WebSocket protocol should theoretically work, but have not been fully tested.

Other browsers supporting the WebSocket protocol include the following:

- Microsoft Internet Explorer 11 and later.
- Mozilla Firefox 30 and later.

## 14.2 Login

The FLIR IP Config scans for cameras automatically. You can identify your camera by the MAC address printed on a label on the side of the camera. Another way to connect is to enter the IP address of your camera into the address bar of a web browser.

To log in to the camera web server interface, follow this procedure:

1. Double-click on the camera in FLIR IP Config. This displays the login view.



2. When logging in for the first time, use the following user login credentials, depending on the type of user:

*User: admin, Password: admin*

*User: user, Password: user*

*User: viewer, Password: viewer*

**Note** It is possible for several users of the type *user* and *viewer* to log in to the camera at the same time. Any changes to the settings and adjustments to an image made by one *user* will be seen by the other logged in users.

If you are logged in as an *admin* user, you will be logged out if another *admin* logs in.

## 14.3 Camera tab

The *Camera* tab is the default tab after logging in. Under the *Camera* tab it is possible to view the video stream from the camera, make measurements, set alarms, take snapshots, calibrate the camera, manage image settings, etc.

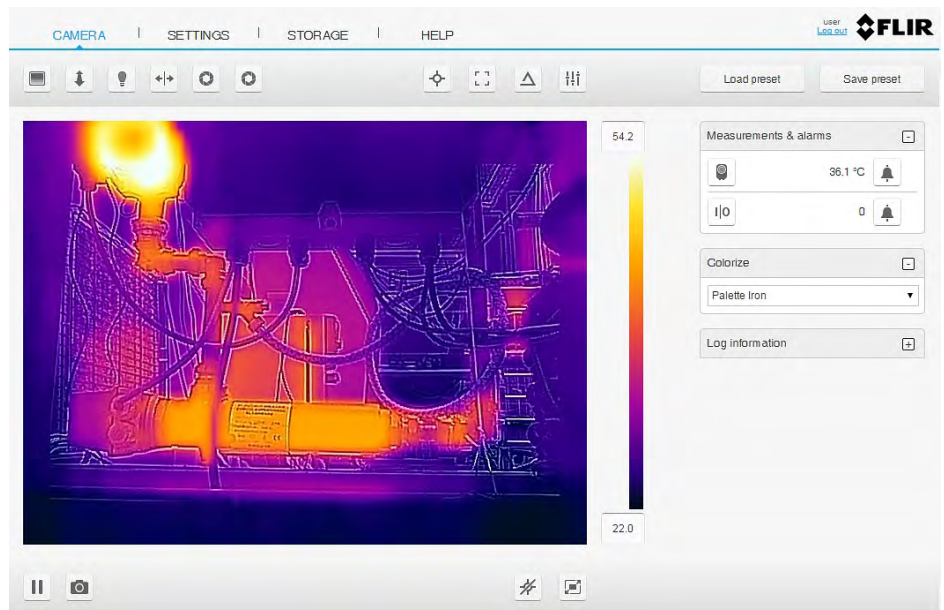

### 14.3.1 Working with image modes

#### 14.3.1.1 General

The camera captures both thermal and visual images at the same time. By your choice of image mode, you select which type of image to display on the screen.

The camera supports the following image modes:

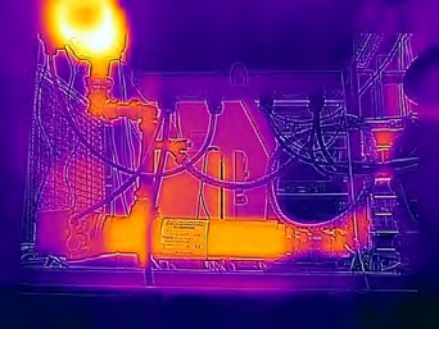
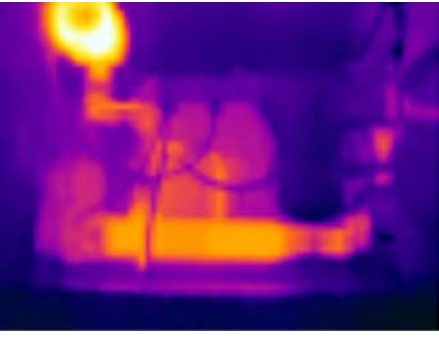
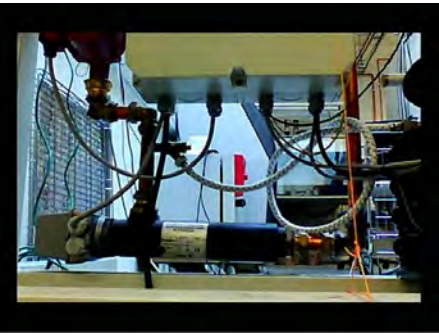
Image mode	Image
<p><i>Thermal MSX</i></p> <p>Multi Spectral Dynamic Imaging—the camera displays infrared images where the edges of the objects are enhanced with visual image details.</p>	
<p><i>Thermal</i></p> <p>A full infrared image is displayed.</p>	
<p><i>Visual</i></p> <p>The visual image captured by the digital camera is displayed.</p>	

To display a good fusion image (*Thermal MSX* mode), the camera must make adjustments to compensate for the small difference in position between the digital camera lens and the infrared lens. To adjust the image accurately, the camera requires the alignment distance (i.e., the distance to the object).

## 14.3.1.2 Selecting the image mode

To select the image mode, follow this procedure:

1. On the upper toolbar, click the *Adjust image mode* icon . This displays a dialog box with radio buttons.

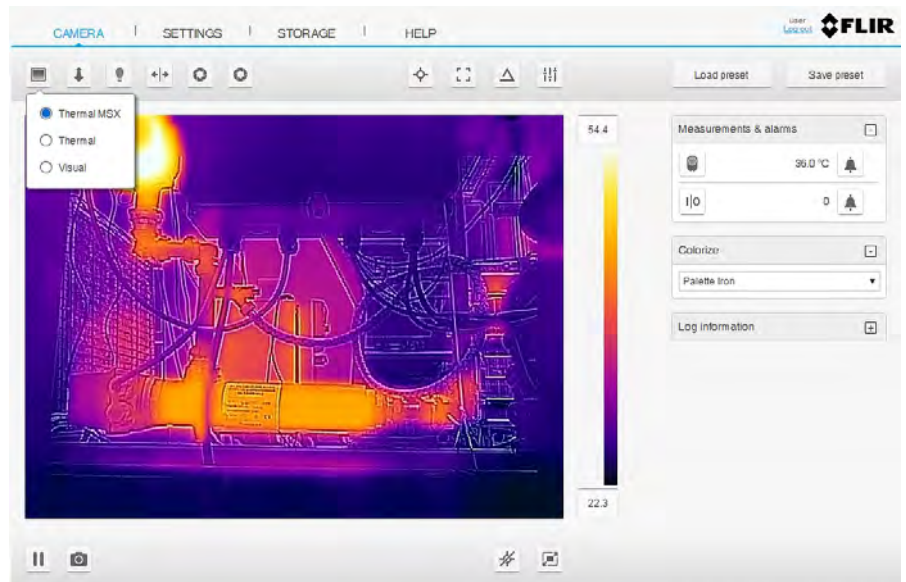

2. Select one of the radio buttons:
  - *Thermal MSX*
  - *Thermal*
  - *Visual*

3. If you have selected *Thermal MSX* mode, also set the distance to the object by doing the following:
  - 3.1. On the upper toolbar, click the *Adjust distance* icon . This displays a dialog box with a slider.

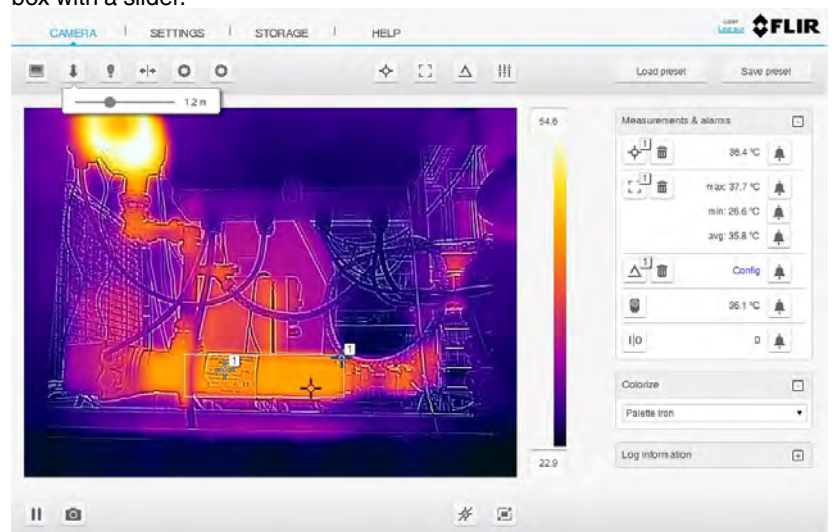

- 3.2. Use the slider to select the distance to the object.



### 14.3.2 Using the camera lamp

#### 14.3.2.1 General

The camera is equipped with a lamp.

#### 14.3.2.2 Procedure

To turn the lamp on and off, follow this procedure:

1. On the upper toolbar, click the *Lamp setting icon* . This displays a dialog box with radio buttons.

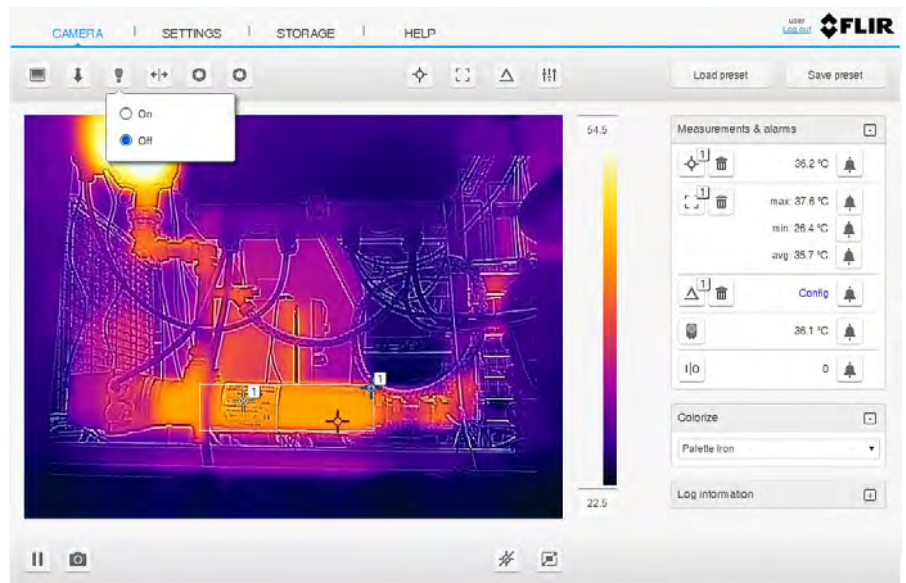

2. Select one of the radio buttons:

- *On*
- *Off*

### 14.3.3 Flipping the video image

#### 14.3.3.1 General

The image can be flipped horizontally or vertically.

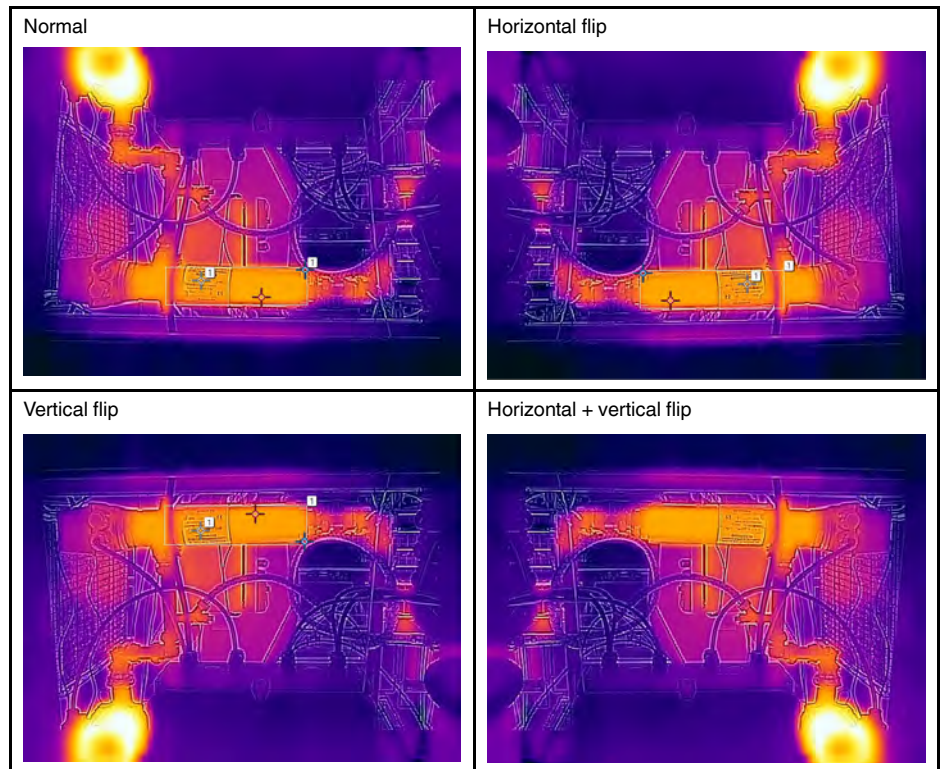

### 14.3.3.2 Procedure

To change the flip setting, follow this procedure:

1. On the upper toolbar, click the *Flip video* icon . This displays a dialog box with check boxes.

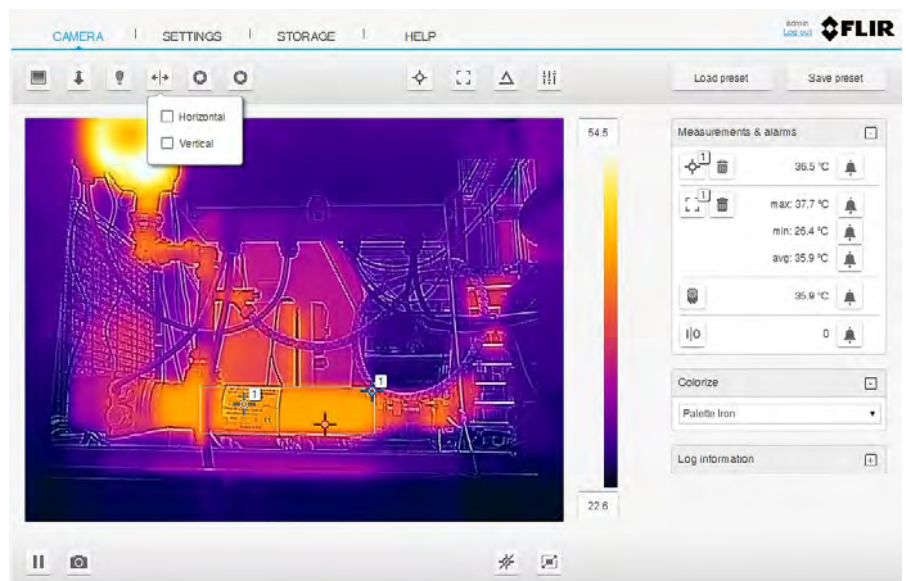

2. Select one or both of the check boxes:
  - *Horizontal*: When selected, the image is flipped horizontally.
  - *Vertical*: When selected, the image is flipped vertically.
3. While the change of the flip setting is in progress, the video stream is paused.

### 14.3.4 Calibrating the camera

#### 14.3.4.1 General

The calibration of the camera is performed as a non-uniformity correction (NUC). An NUC is an image correction carried out by the camera software to compensate for different sensitivities of detector elements and other optical and geometrical disturbances<sup>1</sup>.

Calibration is needed whenever the output image becomes spatially noisy. This may, for example, happen when the ambient temperature changes.

The calibration can be carried out automatically, with different selectable intervals. It is also possible to perform a calibration manually.

#### 14.3.4.2 Automatic calibration

To set the automatic calibration, follow this procedure:

1. On the upper toolbar, click the *Periodic calibration* icon . This displays a dialog box with radio buttons.

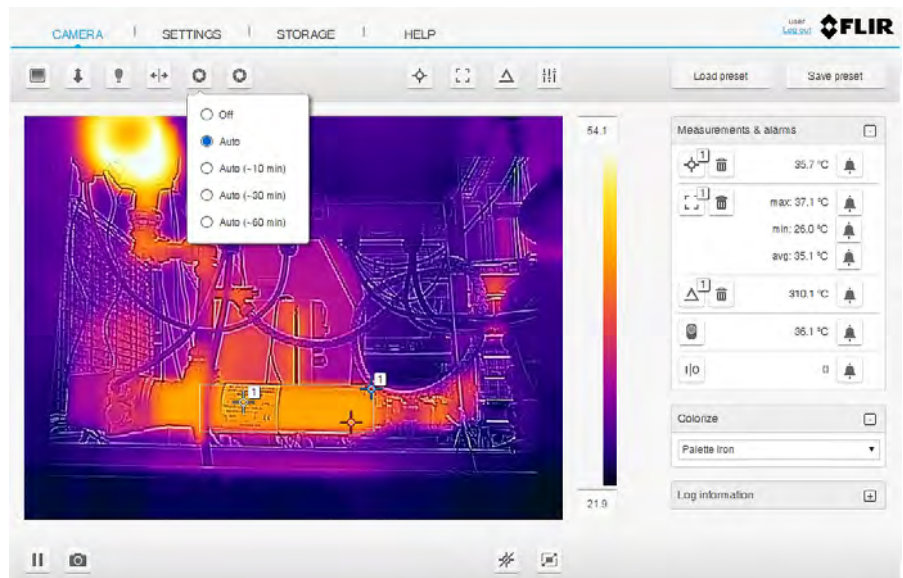

2. Select one of the radio buttons:
  - *Off*: Disable automatic calibration.
  - *Auto*: Calibration is automatically carried out when needed.
  - *Auto (~10 min)*: Calibration is automatically carried out approximately every 10 minutes.
  - *Auto (~30 min)*: Calibration is automatically carried out approximately every 30 minutes.
  - *Auto (~60 min)*: Calibration is automatically carried out approximately every 60 minutes.
3. While the automatic calibration is in progress, the text *Calibrating...* is displayed under the image on the screen.

1. Definition from the impending international adoption of DIN 54190-3 (Non-destructive testing—Thermographic testing—Part 3: Terms and definitions).

#### 14.3.4.3 Manual calibration

To perform a manual calibration, follow this procedure:

1. On the upper toolbar, click the *Calibrate* icon .

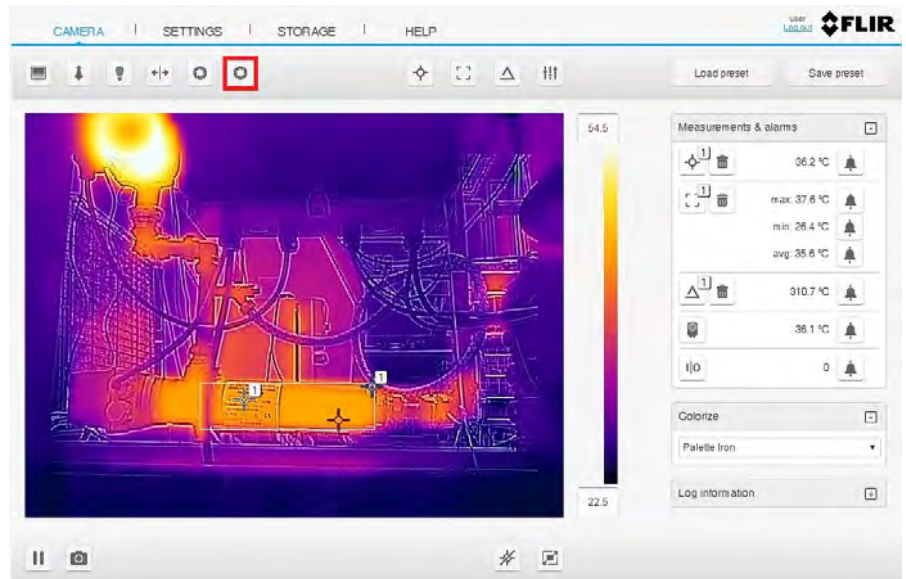

2. While the manual calibration is in progress, the text *Calibrating...* is displayed under the image on the screen.

### 14.3.5 Working with measurement tools

#### 14.3.5.1 General

To measure a temperature, you can use one or more measurement tools, e.g., a spot, box, or delta.

The measurement tools are labeled with a number for identification, according to the order of their creation.

Added measurement tools show up in the *Measurements & alarms* section, where they can be managed and where the measured temperatures are displayed.

#### 14.3.5.2 Spot measurement tool

A spot measurement tool shows the temperature of a specific spot in the image. It is possible to add up to six spots.

To add a spot measurement tool, follow this procedure:

1. On the upper toolbar, click the *Spot measurement* icon . This displays a spot on the image, labeled with a number. The spot tool is also displayed in the *Measurements & alarms* section.

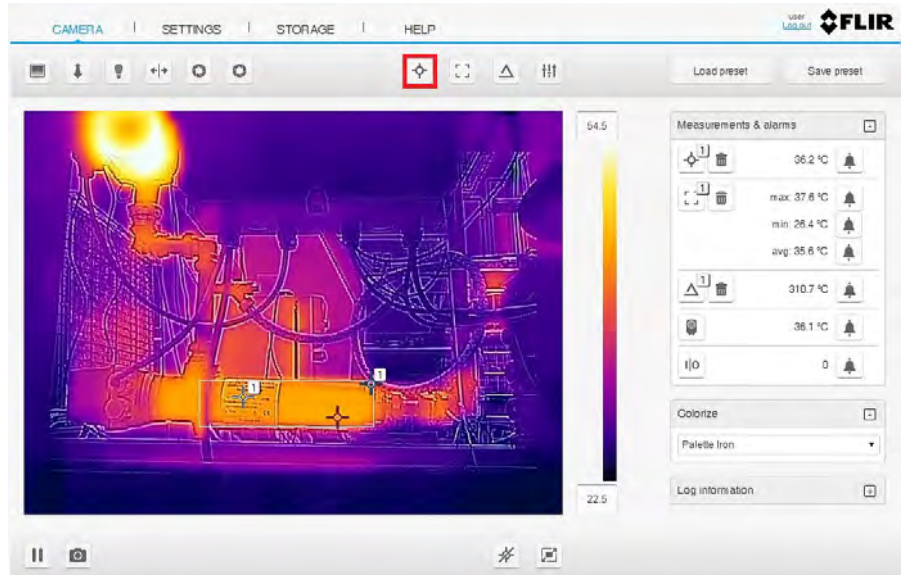

2. To move the spot, click the spot in the image and drag it to the desired location.
3. To set local parameters for the spot, see section 14.3.6.3 *Local parameters*, page 30.
4. To associate an alarm with the spot, see section 14.3.7 *Working with alarms*, page 30.
5. To remove the spot, click the *Delete* icon  next to the tool in the *Measurements & alarms* menu.

#### 14.3.5.3 Box measurement tool



A box measurement tool shows the minimum temperature, the maximum temperature, and the average temperature within a chosen area of the image. It is possible to add up to six boxes.

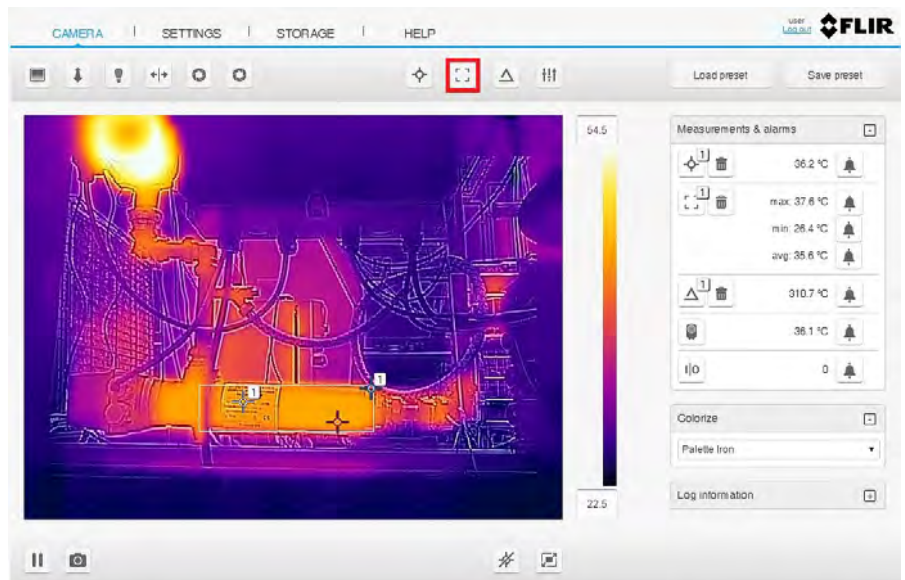

To add a box measurement tool, follow this procedure:

1. On the upper toolbar, click the *Box measurement* icon . This displays a box on the image, labeled with a number and including a hot spot and a cold spot. The box tool is also displayed in the *Measurements & alarms* section.



2. To move the box, click inside the box in the image and drag the box to the desired location.
3. To resize the box, click the border of the box in the image and drag the border to the desired location.
4. To configure settings for the box, do the following:
  - 4.1. In the *Measurements & alarms* section, click the *Box* icon . This displays a dialog box where you can configure the settings.
 
  - 4.2. To set local parameters for the box, see section 14.3.6.3 *Local parameters*, page 30.
  - 4.3. To select what measurement results to display, use the check boxes *Measure box max*, *Measure box min*, and *Measure box avg*.
  - 4.4. To display how much of the box is covered by an isotherm, select the check box *Isotherm coverage (%)*. This setting is only applicable if you have selected a color alarm (isotherm). For more information, see section 14.3.8.3 *Isotherms*, page 34.
  - 4.5. To show/hide the maximum and minimum markers (hot spot and cold spot) in the overlay graphics, select/deselect the check box *Show max & min markers*.
5. To associate an alarm with the box, see section 14.3.7 *Working with alarms*, page 30.
6. To remove the box, click the *Delete* icon  next to the tool in the *Measurements & alarms* menu.

#### 14.3.5.4 Delta measurement tool

The delta measurement tool is used to calculate the difference between two measurement results. It is possible to set up a difference calculation between results from added spots and boxes, as well as a fixed temperature.

To add a delta measurement tool, follow this procedure:

1. On the upper toolbar, click the *Delta measurement* icon . This displays the delta tool in the *Measurements & alarms* section.

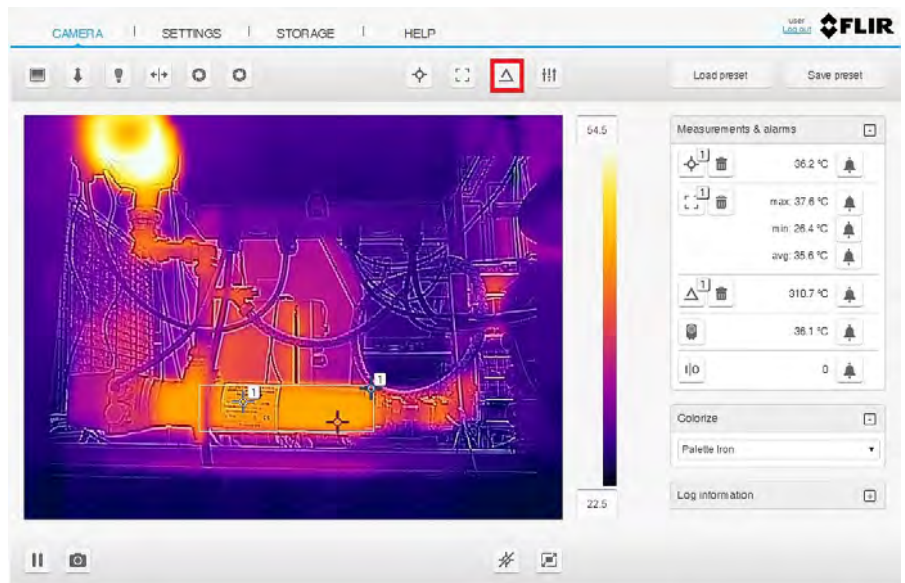

2. In the *Measurements & alarms* section, click the *Delta* icon . This displays a dialog box where you can select the measurement tools you want to use in the difference calculation.



3. Select the first and second parameters from the list boxes. If you select the parameter *Temp*, also enter the fixed temperature in the *Temp* list box.
4. When completed, click anywhere outside the dialog box.

### 14.3.6 Changing object parameters

#### 14.3.6.1 General

For accurate measurements, the camera must be provided with certain object parameters:

- *Emissivity*: How much radiation an object emits, compared with the radiation of a theoretical reference object at the same temperature (called a “blackbody”). The opposite of emissivity is reflectivity. The emissivity determines how much of the radiation originates from the object as opposed to being reflected by it.
- *Reflected temperature*: This is used when compensating for the radiation from the surroundings reflected by the object into the camera. This property of the object is called reflectivity.
- *Relative humidity*: The relative humidity of the air between the camera and the object of interest.
- *Atmospheric temperature*: The temperature of the air between the camera and the object of interest.
- *Distance*: The distance between the camera and the object of interest.
- *External IR window*: Used if any protective windows, etc., are set up between the camera and the object of interest. The settings are On and Off. If On, the following parameters can be set:
  - *Temperature*: The temperature of the external infrared window.
  - *Transmission*: How much of the thermal radiation passes through the window.

You can set the object parameters globally. You can also change the *Emissivity*, *Reflected temperature*, and *Distance* parameters locally for a measurement tool.

**Note** Of the object parameters, *Emissivity* and *Reflected temperature* are the two most important to set correctly in the camera.

#### 14.3.6.2 Global measurement parameters

To change the global measurement parameters, follow this procedure:

1. On the upper toolbar, click the *Global measurement parameters* icon . This displays a dialog box where you can change the values for the object parameters.

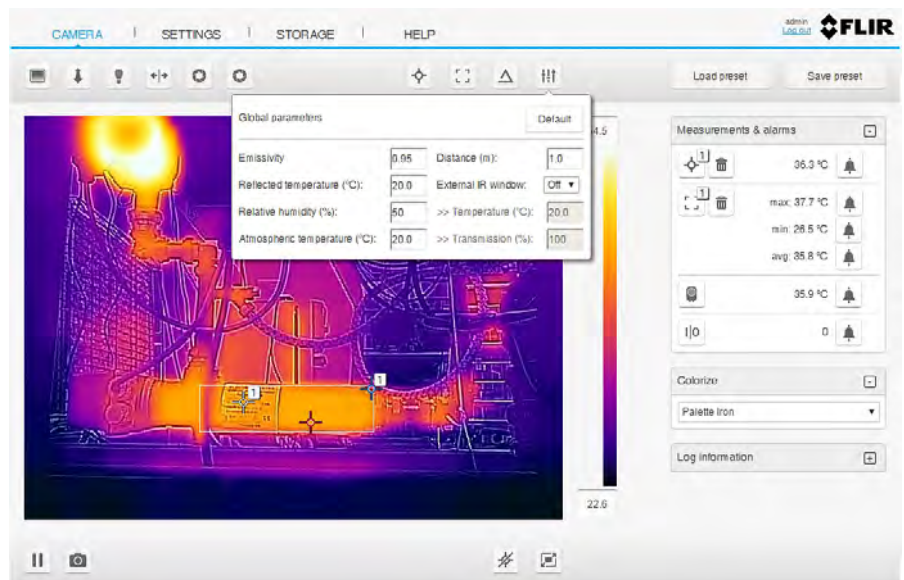



2. To reset the object parameters to the default values provided by FLIR, click the *Default* button.
3. When completed, click anywhere outside the dialog box.

#### 14.3.6.3 Local parameters

It is possible to set local object parameters for spots and boxes. The local parameter settings override the global values.

To change the local object parameters, follow this procedure:

1. In the *Measurements & alarms* section, click the *Spot* icon  or the *Box* icon . This displays a dialog box.



2. In the *Local parameters* list box, select *On*. This activates the use of local parameters and allows you to change the values for the object parameters *Emissivity*, *Reflected temperature*, and *Distance*.
3. To reset the object parameters to the global values, click the *Reset* button.
4. To deactivate the use of local parameters, select *Off* in the *Local parameters* list box.
5. When completed, click anywhere outside the dialog box.

### 14.3.7 Working with alarms

#### 14.3.7.1 General

You can make the camera trigger an alarm when certain conditions are met. An alarm can be triggered by several different sources, such as a measurement result in the image, a digital input, or an internal temperature sensor.



When an alarm is triggered, the camera can perform one or more tasks, e.g., save an image or video sequence to memory, e-mail the image/video to predefined recipients, and send the image to an FTP site. The camera can also further trigger a variety of external devices, using the digital output.

When an alarm is activated, the *Alarm settings* icon is marked with a blue frame: .

When an alarm is triggered, the *Alarm settings* icon is marked with a red frame: .

#### 14.3.7.2 Setting an alarm based on a measurement result

It is possible to configure alarms based on the temperature measurement results from the spot, box, and delta measurement tools. An alarm can also be configured for the internal temperature sensor, which can act as a thermometer for the ambient temperature.

To configure an alarm based on a measurement result, follow this procedure:

1. In the *Measurements & alarms* section, click the *Alarm* icon  next to the measurement result to be used for the alarm. This displays a dialog box where you can configure the alarm parameters and actions.

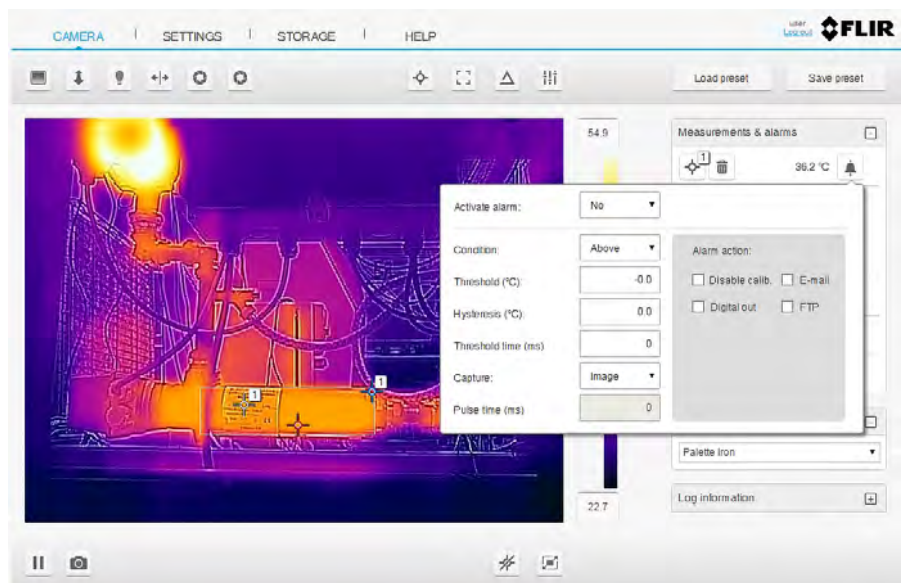

2. In the *Activate alarm* list box, select *Yes* to activate the alarm.
3. In the *Condition* list box, select the condition that triggers the alarm:
  - *Above*: Triggers an alarm when the temperature is above the threshold value.
  - *Below*: Triggers an alarm when the temperature is below the threshold value.
4. In the *Threshold* text box, enter the temperature value to be used as the trigger limit.
5. In the *Hysteresis* text box, enter the hysteresis value.

Hysteresis is the interval within which the temperature value is allowed to vary without causing a change in the trigger. If the threshold is set above 30.0°C and the hysteresis is set at 2.0°C, the trigger goes high when the temperature rises above 30.0°C and stays high until the temperature drops below 28.0°C. In contrast, if the threshold is set below 30.0°C, and the same hysteresis value is kept, the trigger goes high if the temperature drops below 30.0°C and stays high until the temperature rises above 32.0°C.

6. In the *Threshold time* text box, enter the duration that must be matched or exceeded in order for the alarm to be triggered.

The duration specifies the amount of time that has to pass before an alarm is triggered. This can be used as a powerful tool to avoid false alarms.

7. In the *Capture* list box, select if an image or a video sequence will be captured and saved when an alarm is triggered. The image/video can later be viewed and managed under the *Storage* tab.
  - Select *Image* to capture the image frame that triggered the alarm.
  - Select *Video* to capture a 5 second video sequence when the alarm is triggered.
  - If you select *None*, no image/video will be captured.
8. Under *Alarm action*, use the check boxes to select which actions the camera will perform when an alarm is triggered:
  - *Disable calib.*: Temporarily disables the periodic calibration while the image/video is being captured.
  - *E-mail*: Automatically sends the captured image/video to the recipients defined in *Settings > Alarm recipients*.
  - *Digital out*: Outputs a digital pulse.
  - *FTP*: Automatically sends the captured image/video to the FTP site defined in *Settings > Alarm recipients*.
9. If you have selected the alarm action *Digital out*, enter the pulse length (in milliseconds) in the *Pulse time* text box.
10. When completed, click anywhere outside the dialog box.

#### 14.3.7.3 Setting an alarm based on the digital input

It is possible to set an alarm based on the digital input.

To configure an alarm based on the digital input, follow this procedure:

1. In the *Measurements & alarms* section, click the *Alarm* icon  next to the digital input result. This displays a dialog box where you can configure the alarm parameters and actions.

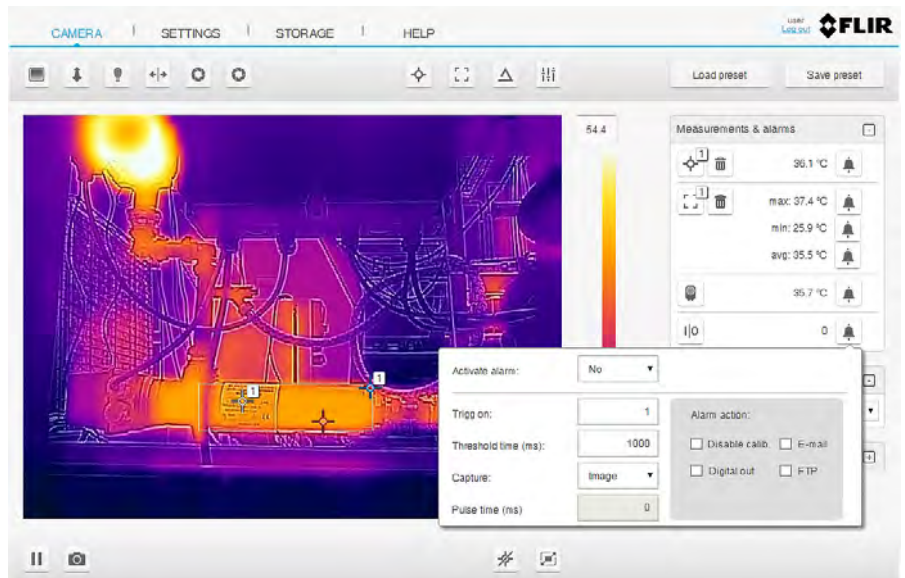

2. In the *Activate alarm* list box, select *Yes* to activate the alarm.
3. In the *Trigg on* text box, enter 0 to trigger the alarm on a low signal or 1 to trigger on a high signal.
4. In the *Threshold time* text box, enter the duration that must be matched or exceeded in order for the alarm to be triggered.

The duration specifies the amount of time that has to pass before an alarm is triggered. This can be used as a powerful tool to avoid false alarms.

5. In the *Capture* list box, select if an image or a video sequence will be captured and saved when an alarm is triggered. The image/video can later be viewed and managed under the *Storage* tab.
  - Select *Image* to capture the image frame that triggered the alarm.
  - Select *Video* to capture a 5 second video sequence when the alarm is triggered.
  - If you select *None*, no image/video will be captured.
6. Under *Alarm action*, use the check boxes to select which actions the camera will perform when an alarm is triggered:
  - *Disable calib.*: Temporarily disables the periodic calibration while the image/video is being captured.
  - *E-mail*: Automatically sends the captured image/video to the recipients defined in *Settings > Alarm recipients*.
  - *Digital out*: Outputs a digital pulse.
  - *FTP*: Automatically sends the captured image/video to the FTP site defined in *Settings > Alarm recipients*.
7. If you have selected the alarm action *Digital out*, enter the pulse length (in milliseconds) in the *Pulse time* text box.
8. When completed, click anywhere outside the dialog box.

### **14.3.8 Colorizing the image**

#### 14.3.8.1 General

The camera can colorize the image in different ways. You can select different color palettes or apply color alarms (isotherms).

#### 14.3.8.2 Palette

You can change the palette that the software uses to display the different temperatures within an image. A different palette can make it easier to analyze the image. The most suitable palette for a certain application depends on many different factors, such as the target temperature and emissivity, the ambient temperature, and the distance to the target. You will need to test different palettes in order to find the one that best suits your application.

The camera supports the following palettes:

- *Palette Arctic*
- *Palette Gray*
- *Palette Iron*
- *Palette Lava*
- *Palette Rainbow*
- *Palette Rainbow HC*

To change the palette, follow this procedure:

1. In the *Colorize* list box, select one of the palettes.

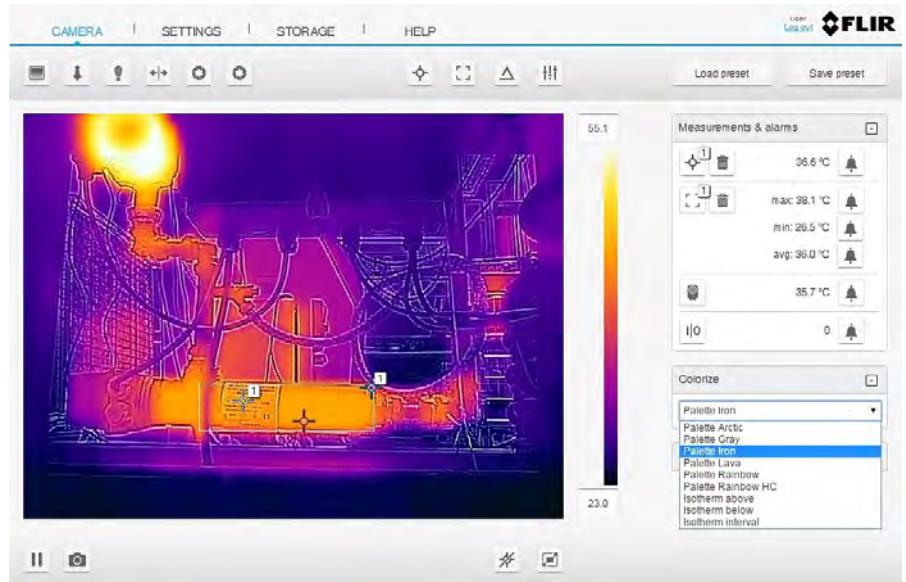

#### 14.3.8.3 Isotherms

By using color alarms (isotherms), anomalies can easily be discovered in an infrared image. The isotherm command applies a contrasting color to all pixels with a temperature above, below, or between the set temperature levels.

The camera supports the following color alarms (isotherms):

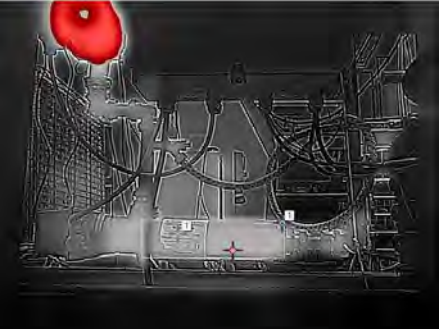
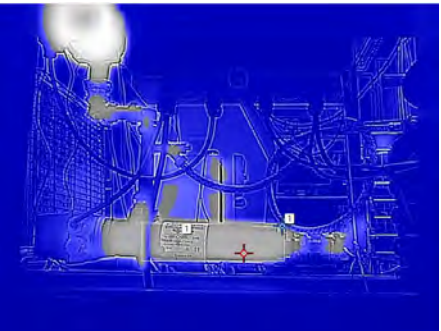
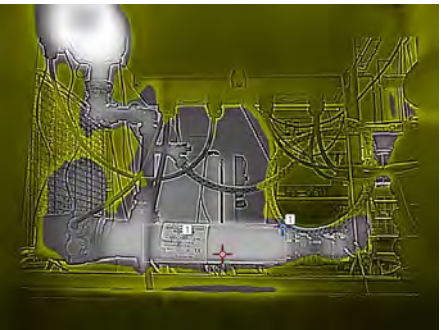
Color alarm	Image
<p><i>Isotherm above</i></p> <p>Applies a contrasting color (red) to all pixels with a temperature above the specified temperature level.</p>	
<p><i>Isotherm below</i></p> <p>Applies a contrasting color (blue) to all pixels with a temperature below the specified temperature level.</p>	
<p><i>Isotherm interval</i></p> <p>Applies a contrasting color (yellow) to all pixels with a temperature between two specified temperature levels.</p>	

To configure a color alarm (isotherm), follow this procedure:

1. In the *Colorize* list box, select one of the color alarms:

- *Isotherm above*
- *Isotherm below*
- *Isotherm interval*

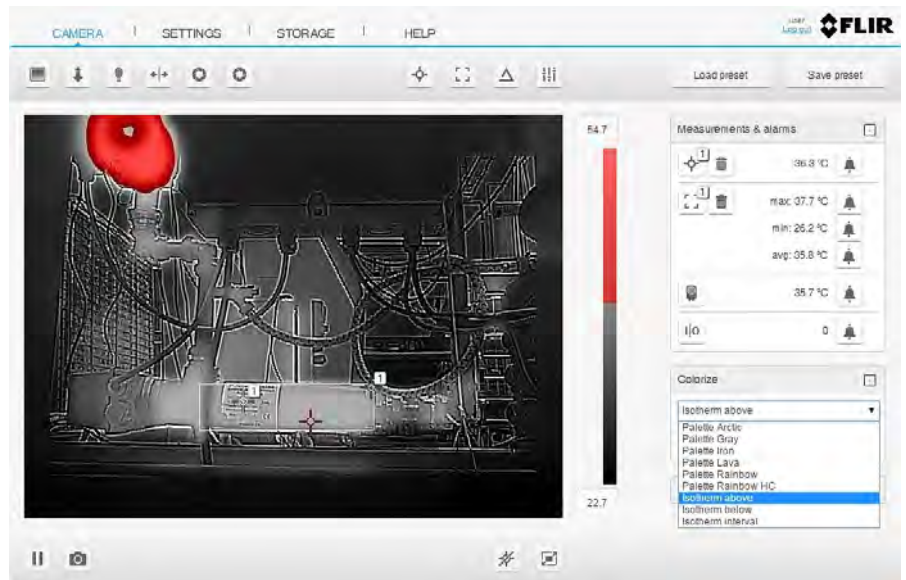

2. When a color alarm is selected, the threshold temperature(s) are displayed in the *Colorize* section.

To change the threshold temperature, do the following:

- For the *Isotherm above*, enter the threshold temperature in the *From* text box.
- For the *Isotherm below*, enter the threshold temperature in the *To* text box.
- For the *Isotherm interval*, enter the threshold temperatures in the *From* and *To* text boxes.



### 14.3.9 Adjusting the temperature scale

#### 14.3.9.1 General

The camera continuously auto-adjusts the image for the best image brightness and contrast. In some situations, manual adjustments can make it easier to analyze details in the image. For example, by manually changing the maximum and/or minimum temperature levels to levels near a certain object in the image, you can study temperature variations in the object.

When a temperature level is manually adjusted, the temperature level text box is marked with a blue frame and the *Auto* button is displayed:

To return to auto-adjustment of the temperature level, click the *Auto* button.



## 14.3.9.2 Procedure

To manually adjust the image, follow this procedure:

1. To change the maximum temperature level, enter the temperature in the upper temperature scale text box. When completed, click anywhere outside the text box.

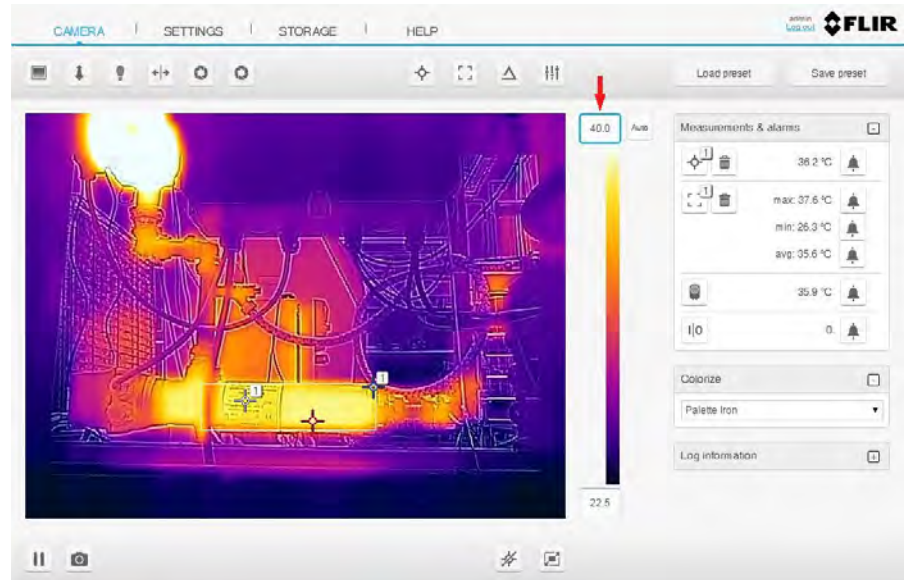

2. To change the minimum temperature level, enter the temperature in the lower temperature scale text box. When completed, click anywhere outside the text box.

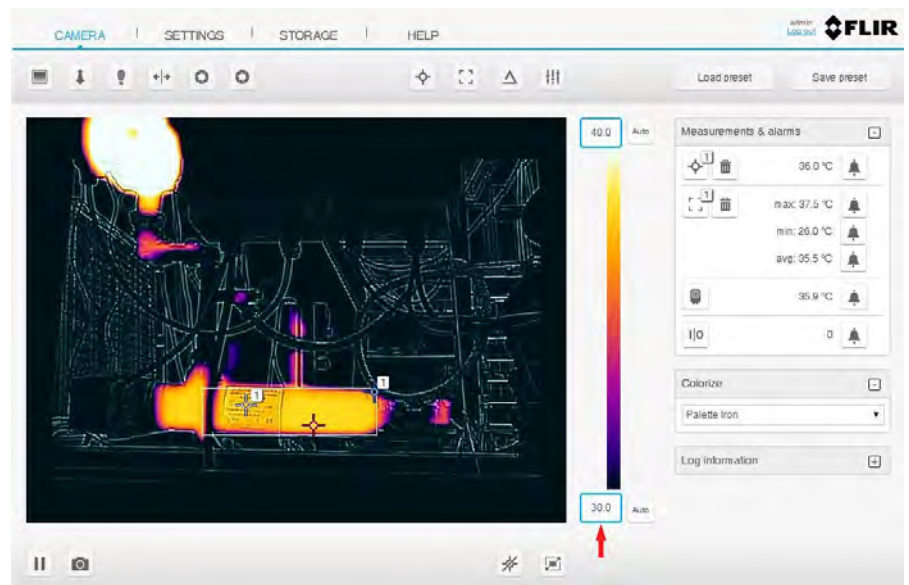

3. To return to auto-adjustment, click the *Auto* button(s).

## 14.3.10 Log information

## 14.3.10.1 General

The *Log information* section lists information about triggered alarms.

It is possible to save the displayed log information to a text file. The log file is saved to disk in your Downloads folder.

### 14.3.10.2 Procedure

To manage the log information, follow this procedure:

1. In the *Log information* section, click the expand icon.

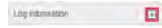

2. This displays the list with information about triggered alarms.



3. To clear the log information list, click *Clear*.
4. To save the log information list to a text file, click *Save*.

### 14.3.11 Camera presets

#### 14.3.11.1 General

It is possible to save the current camera setup, including measurement tool configurations, alarms, and colorization settings. The file with the presets is saved to disk in your Downloads folder.

The presets file can later be uploaded and applied.

#### 14.3.11.2 Saving a preset

To save the current camera setup, follow this procedure:

1. On the upper toolbar, click the *Save preset* button.

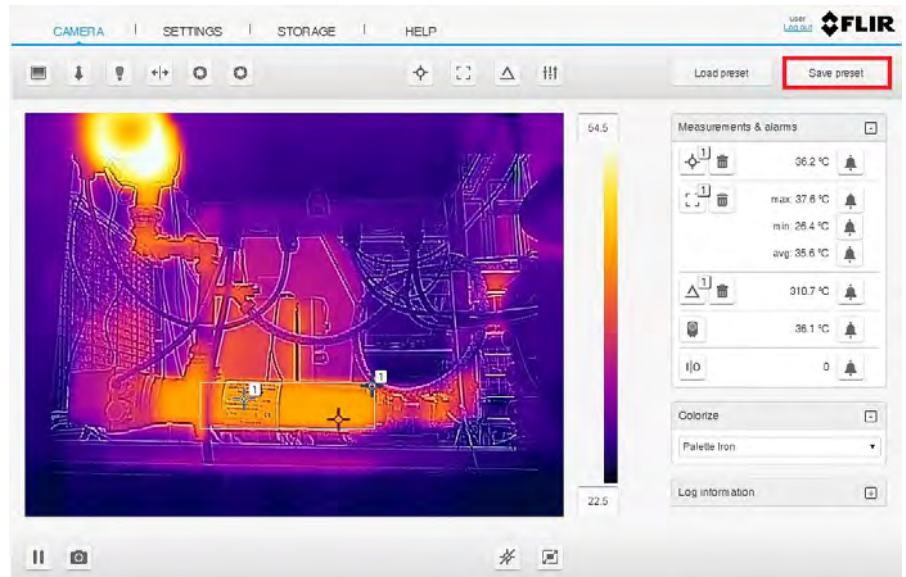



### 14.3.11.3 Loading a preset

To load a saved preset file, follow this procedure:

1. On the upper toolbar, click the *Load preset* button. This opens the standard Windows Open dialog box.

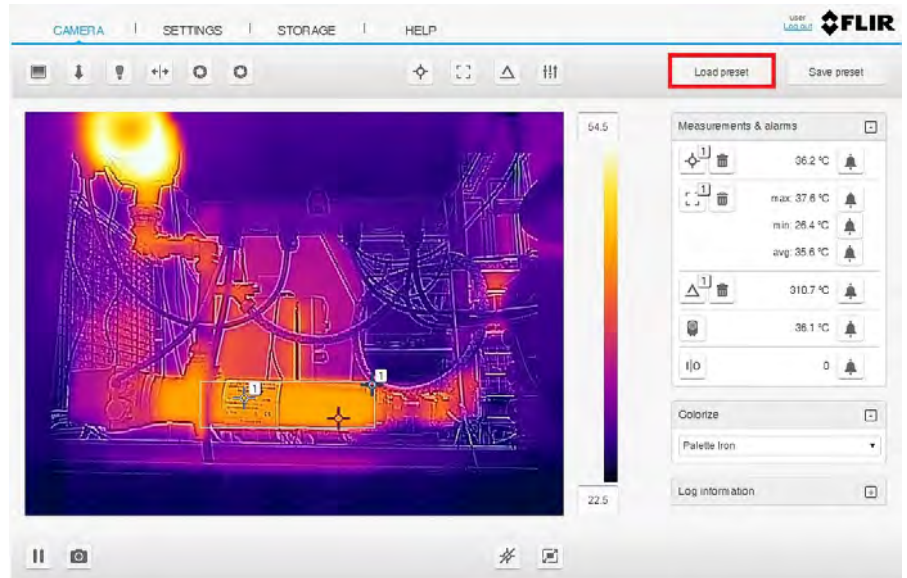

2. Browse to the Downloads folder (or to the folder where you have stored the preset files).



3. Select the file and click the *Open* button. This loads and applies the presets.

### 14.3.12 Pausing the live video

#### 14.3.12.1 General

It is possible to pause (freeze) the live video stream.

## 14.3.12.2 Procedure

To pause the video stream, follow this procedure:

1. On the lower toolbar, click the *Pause* icon .

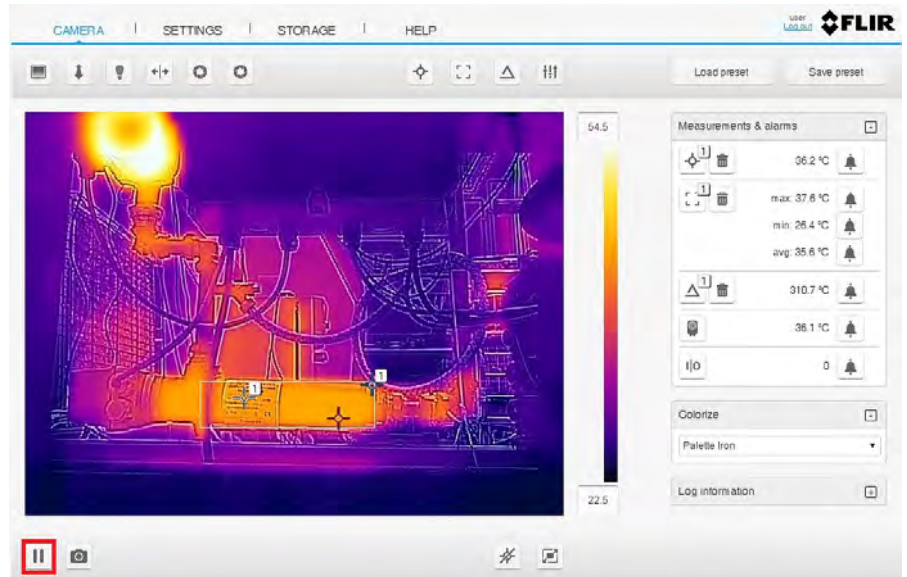

2. When the video stream is paused, the text *Live stream is paused* is temporarily displayed under the image on the screen.
3. To resume the live video stream, click the *Play* icon  on the lower toolbar.

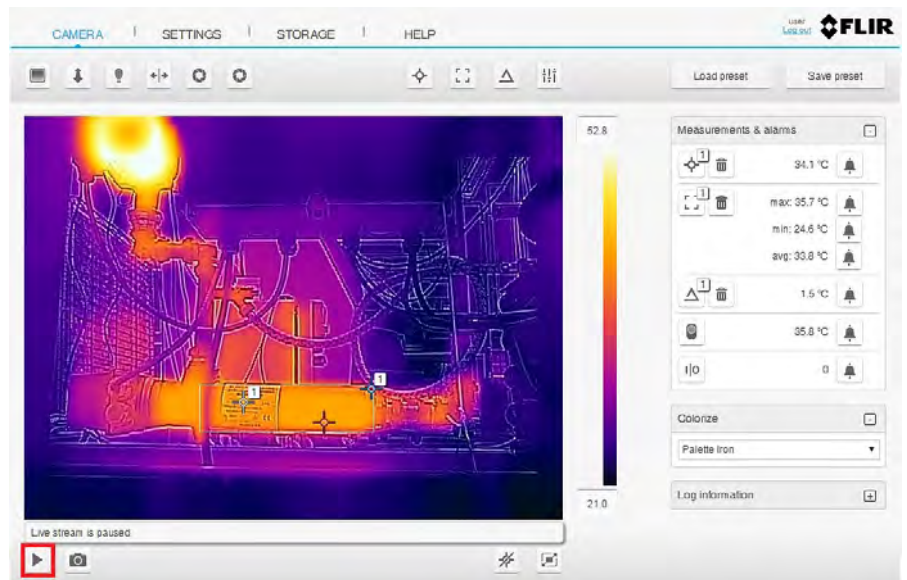

## 14.3.13 Saving a snapshot

## 14.3.13.1 General

It is possible to take a snapshot and save the image with the current measurement results. The image can later be viewed and managed under the *Storage* tab. Up to 50 images can be saved.

Example of a saved snapshot:

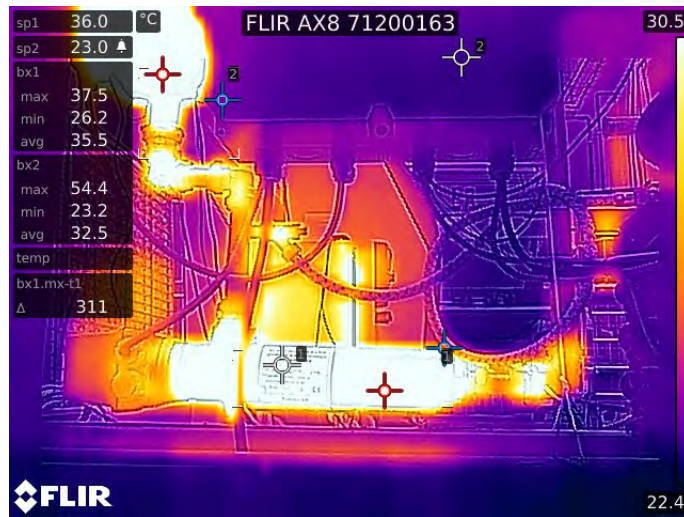

#### 14.3.13.2 Procedure

To take a snapshot, follow this procedure:

1. On the lower toolbar, click the *Save snapshot* icon .

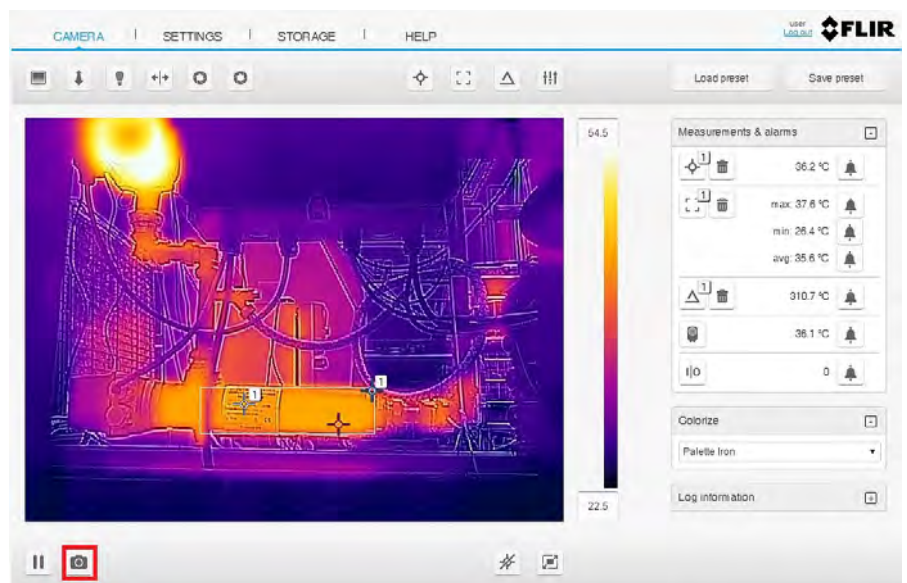

2. When saving is in progress, the image filename is temporarily displayed under the image on the screen.

#### 14.3.14 Hiding the overlay graphics

The overlay graphics provide information about the image, e.g., measurement tools. You can choose to hide all overlay graphics.

To hide the overlay graphics, follow this procedure:

1. On the lower toolbar, click the *Hide overlay* icon .

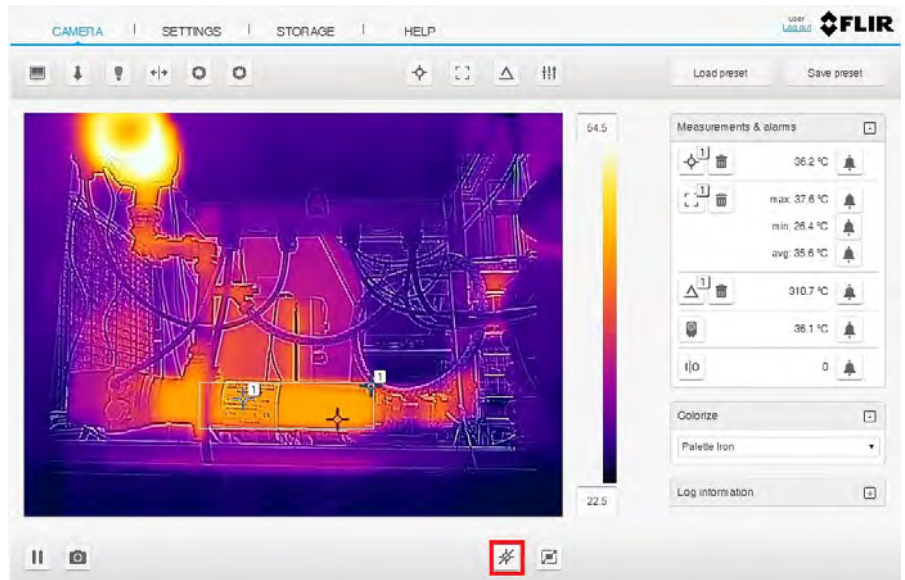

2. To show the overlay graphics, click the *Hide overlay* icon  once more.

### 14.3.15 Full screen view

#### 14.3.15.1 General

It is possible to display a full screen view of the image.

#### 14.3.15.2 Procedure

To view the image in full screen, follow this procedure:

1. On the lower toolbar, click the *Full screen* icon .

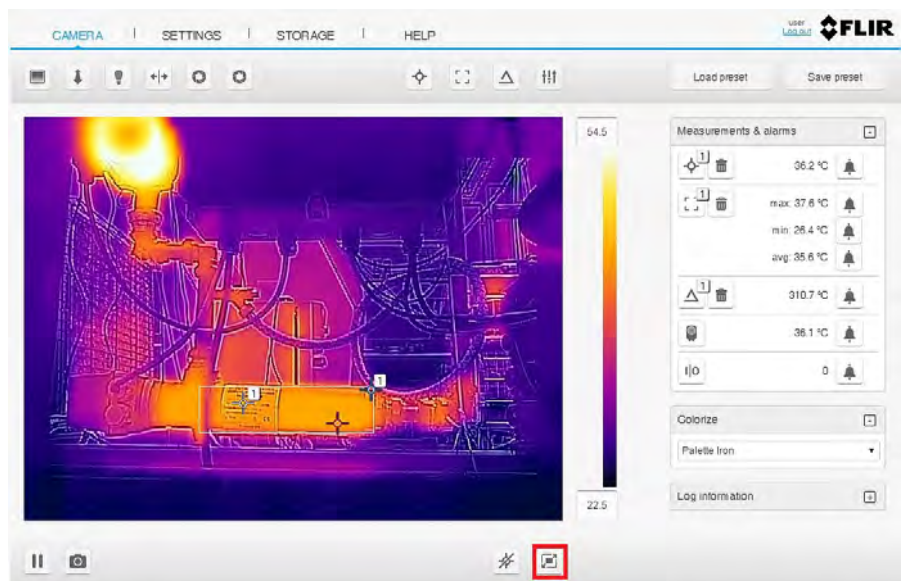

2. To return to normal view, press the Esc (Escape) key on the computer keyboard.



### 14.3.16 Live image only

#### 14.3.16.1 General

It is possible to navigate to a web page that displays only the live image, with or without the overlay graphics.

**Note** JavaScript has to be enabled in your web browser.

Examples of live image web pages:

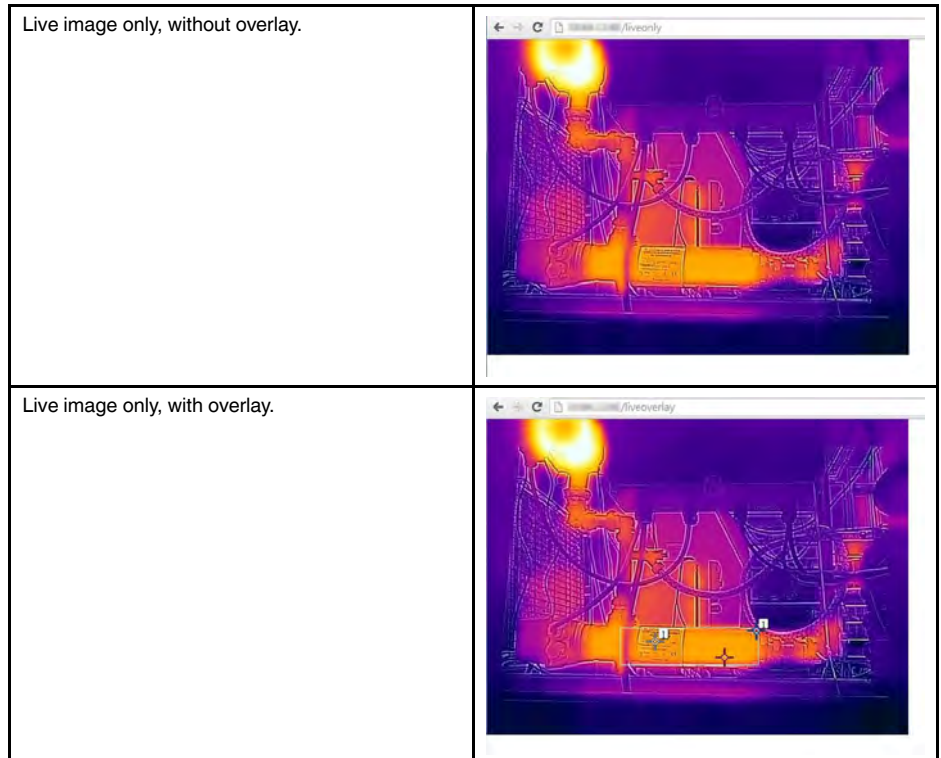

#### 14.3.16.2 Procedure

To navigate to a live image web page, follow this procedure:

- In the address bar of a web browser, enter one of the following:
  - `<ip-address>/liveonly`—shows the live image, without overlay, if already logged in, otherwise the login view is displayed.
  - `<ip-address>/liveonly/username:password`—logs in automatically and shows the live image, without overlay.
  - `<ip-address>/liveoverlay`—shows the live image, with overlay, if already logged in, otherwise the login view is displayed.
  - `<ip-address>/liveoverlay/username:password`—logs in automatically and shows the live image, with overlay.

### 14.4 Settings tab

Under the *Settings* tab it is possible to manage the Camera ID, Regional settings, Network settings, User settings, Alarm recipients, Web interface theme, System, and Firmware details.

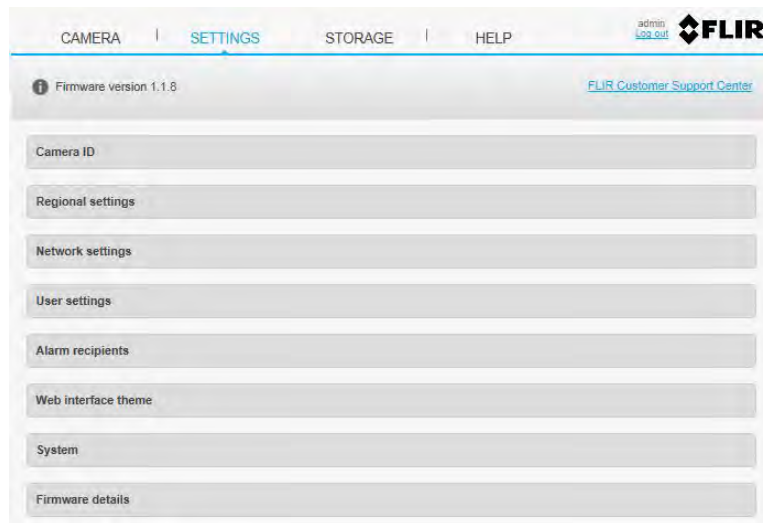

### 14.4.1 Camera ID

#### 14.4.1.1 General

You can choose to show or hide the camera ID. When shown, the camera ID appears as the tab ID in the web browser and in the upper part of saved snapshots.

It is also possible to change the camera ID text.

#### 14.4.1.2 Procedure

To manage the camera ID, follow this procedure:

1. Click on *Camera ID*. This displays the camera ID settings.

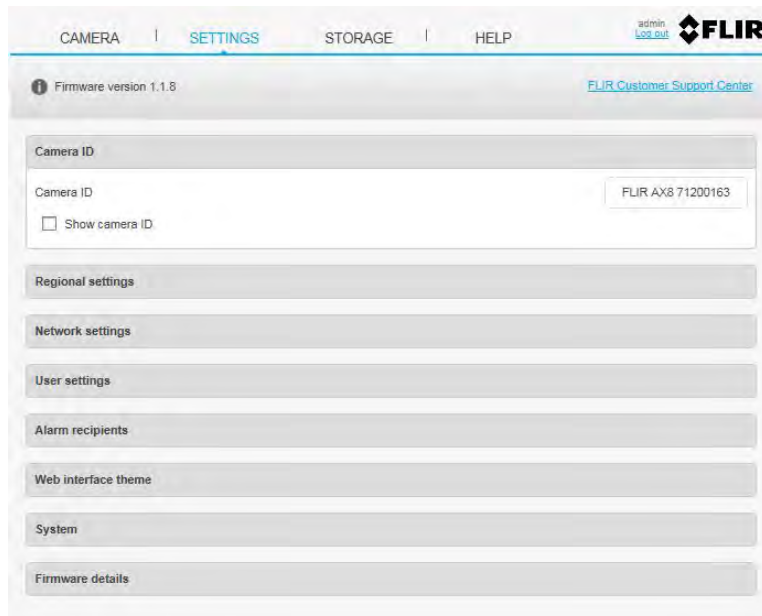

2. To show the camera ID, select the check box *Show camera ID*.
3. To change the camera ID, enter the text in the text box to the right.

## 14.4.2 Regional settings

### 14.4.2.1 General

It is possible to change the regional settings, such as the temperature and distance units, date and time settings, and time zone.

### 14.4.2.2 Procedure

To manage the regional settings, follow this procedure:

1. Click on *Regional settings*. This displays the regional settings.

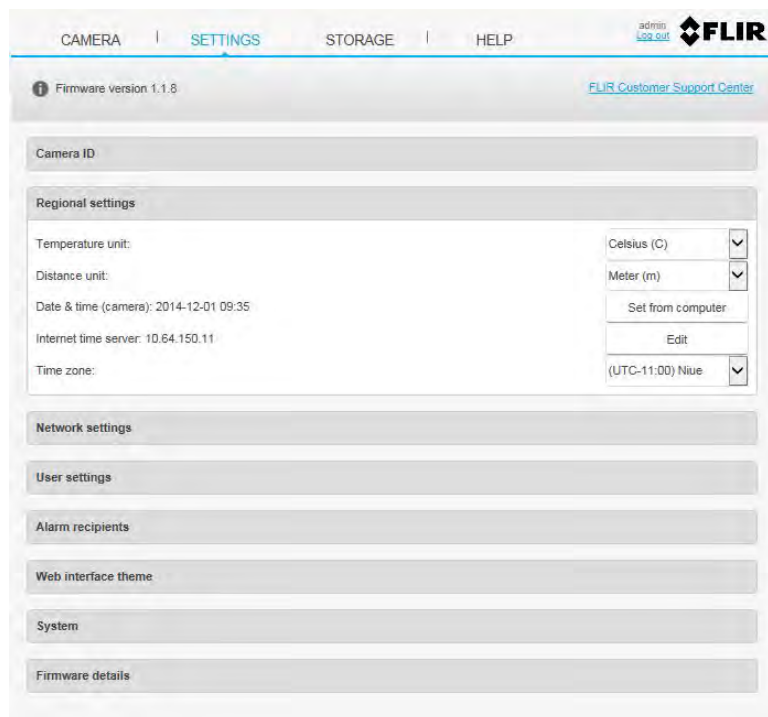

2. To change the temperature unit, select *Celsius (C)* or *Fahrenheit (F)* from the *Temperature unit* list box.
3. To change the distance unit, select *Meter (m)* or *Feet (ft)* from the *Distance unit* list box.
4. To apply the date and time settings from the computer, click the *Set from computer* button.
5. To apply the date and time settings from an internet time server (SNTP), do the following:
  - 5.1. Click the *Edit* button. This displays a text box.
  - 5.2. In the text box, enter the IP address of the internet time server.
  - 5.3. Click the *Apply* button.
6. To change the time zone, select the correct time zone from *Time zone* the list box.

## 14.4.3 Network settings

### 14.4.3.1 General

It is possible to manage the network setup and to select the streaming bit rate.

**Note** When altering the network settings, the address of the camera might change. Make sure your settings are correct before saving them or the camera might not be reachable afterwards. If this occurs, you can use FLIR IP Config to locate the camera again or reset the camera to its default settings.

### 14.4.3.2 Procedure

To manage the network settings, follow this procedure:

1. Click on *Network settings*. This displays the network settings.

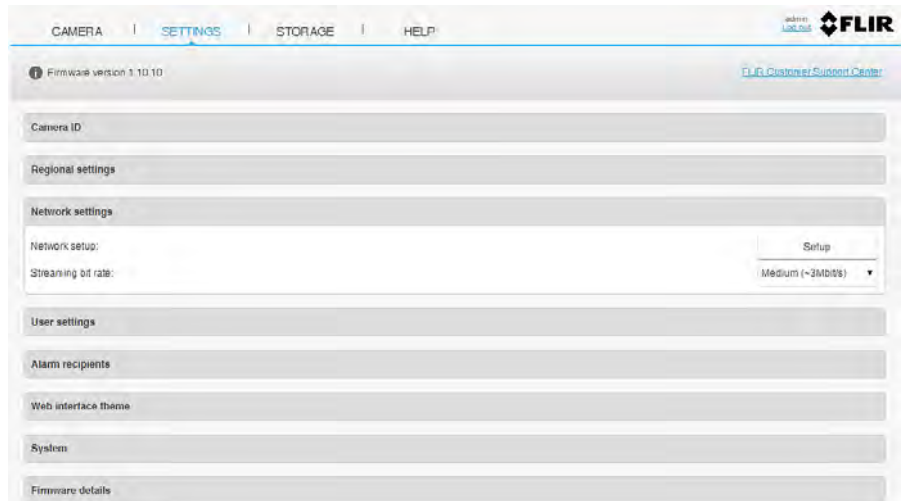

2. To manage the network setup, click the *Setup* button. This displays a dialog box.

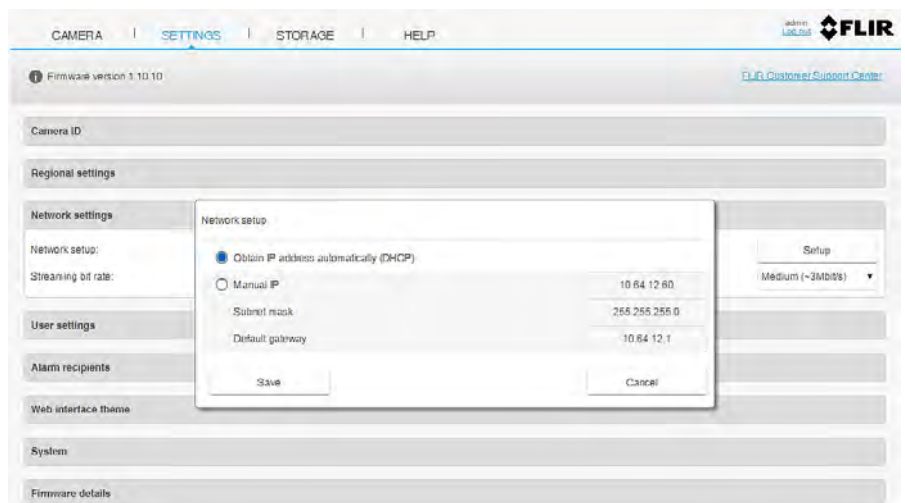

3. To obtain the IP address automatically, select the radio button *Obtain IP address automatically (DHCP)*.
4. To set the IP address manually, select the radio button *Manual IP* and do the following:
  - 4.1. Enter the IP address of the camera.
  - 4.2. Enter the Subnet mask.
  - 4.3. Enter the IP address of the default gateway.
  - 4.4. When completed, click the *Save* button.
5. To change the streaming bit rate, select *Low*, *Medium*, or *High* from the *Streaming bit rate* list box.

## 14.4.4 User settings

### 14.4.4.1 General

There are three types of users: *admin*, *user*, and *viewer*.

A user of the *admin* type can change the passwords for all types of users.

If a password is changed for a logged-in user, their web user interface will restart.



## 14.4.4.2 Procedure

To change a password, follow this procedure:

1. Log in to the camera web server as an *admin* user.
2. Click on *User settings*. This displays the user settings.

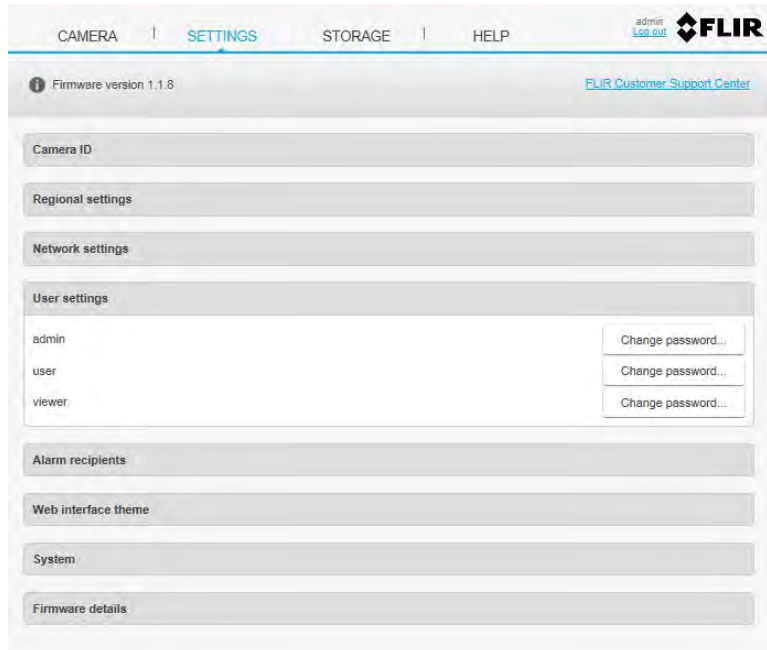

3. Click the *Change password...* button. This displays a dialog box.

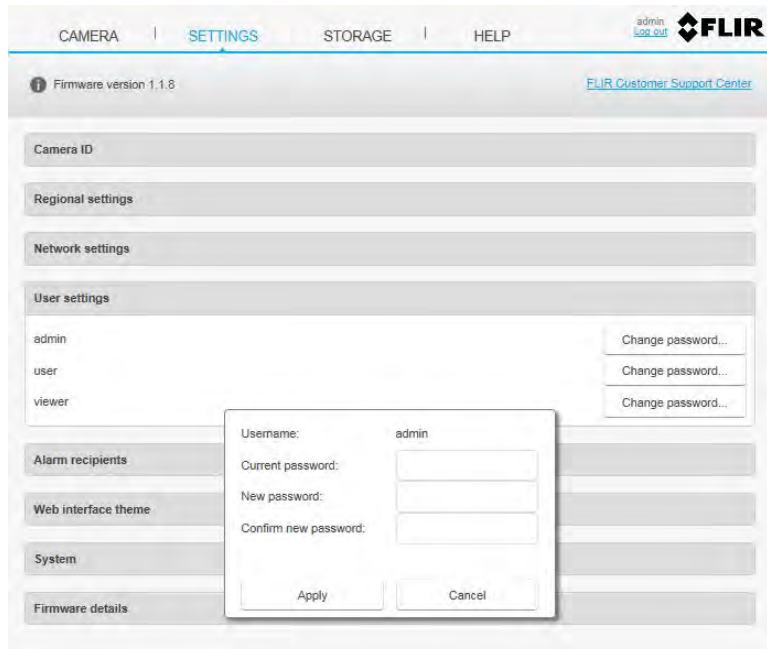

4. Enter the current and new passwords in the *Current password*, *New password*, and *Confirm new password* text boxes.
5. Click the *Apply* button.

### 14.4.5 Alarm recipients

#### 14.4.5.1 General

It is possible to change the e-mail and FTP recipients of alarm notifications. You can also enter the login credentials, in case the mail server requires authentication.

**Note** Only SMTP mail servers are supported.

Supported authentication methods are PLAIN and LOGIN. SSL authentication is not supported.

#### 14.4.5.2 Procedure

To manage the alarm recipients, follow this procedure:

1. Click on *Alarm recipients*. This displays the alarm recipients settings.

2. To change the *E-mail* address, do the following:

- 2.1. Click the *Edit* button and enter the e-mail address in the displayed text box. The format should be user@domain:mailserver. The mailserver needs to be an IP number and not a DNS name, e.g., john.doe@company.com:XX.XX.XX.XX. The following characters can be used:

- a–z
- A–Z
- 0–9
- \$ - \_ . + ! \* ' { } | ^ [ ] ` # % ? @ & =

- 2.2. If the mail server requires a login, select the check box *Authenticate e-mail*.
- 2.3. To enter the *User* for the mail server authentication, click the *Edit* button.
- 2.4. To enter the *Password* for the mail server authentication, click the *Edit* button.

3. To change the *FTP* address, do the following:

- 3.1. Click the *Edit* button and enter the IP address of the FTP server in the displayed text box. The format should be user:password@ftpserver-ip-address.
- 3.2. To specify which *Folder* to save the notifications to, click the *Edit* button. This can be useful if you have multiple cameras connected to the same FTP server.

### 14.4.6 Web interface theme

#### 14.4.6.1 General

It is possible to change the theme (background color) for the web interface. Choose between Dark precision and Light precision.

#### 14.4.6.2 Procedure

To manage the web interface theme, follow this procedure:

1. Click on *Web interface theme*. This displays the theme settings.
2. For the dark background color, select the radio button *Dark precision*.

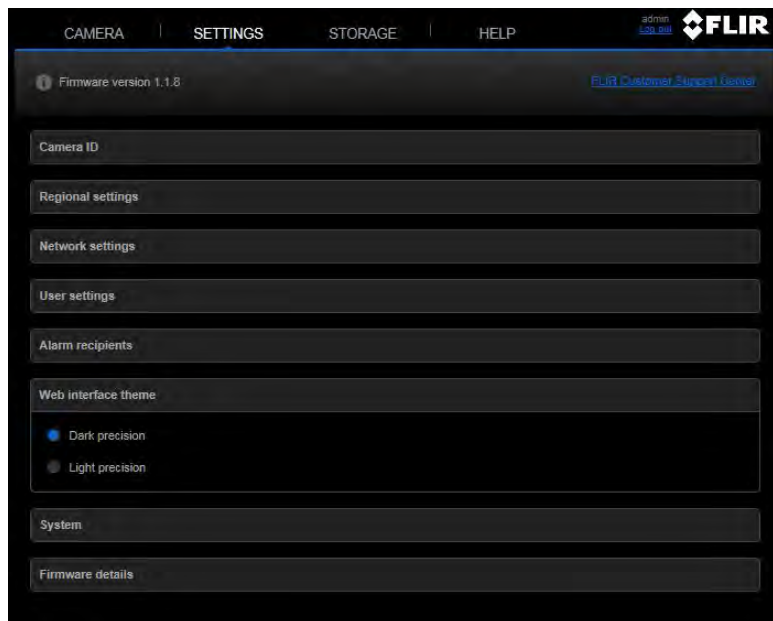

3. For the light background color, select the radio button *Light precision*.

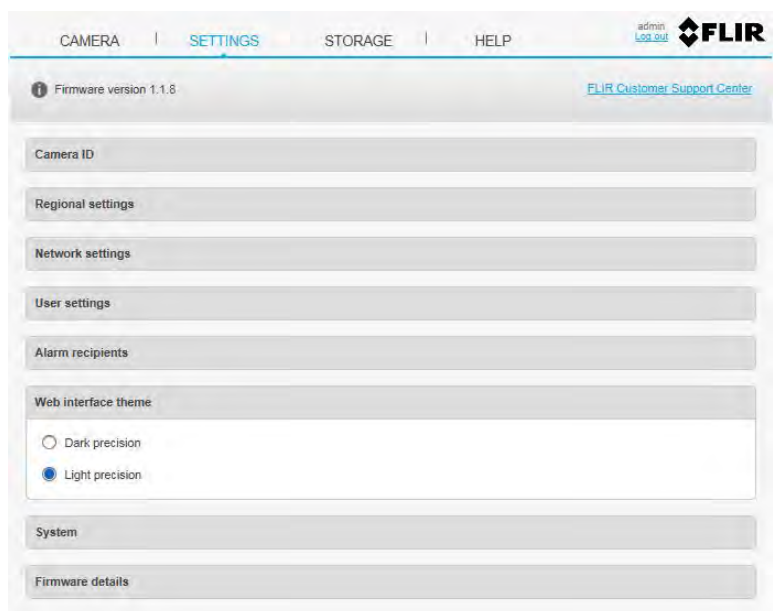

### 14.4.7 System

#### 14.4.7.1 General

The *System* section displays the serial number and the part number of the camera. Here, you can also restart the camera, reset the camera to factory default settings, and update the camera firmware.

#### 14.4.7.2 Procedure

To manage the system functions, follow this procedure:

1. Click on *System*. This displays the system functions.

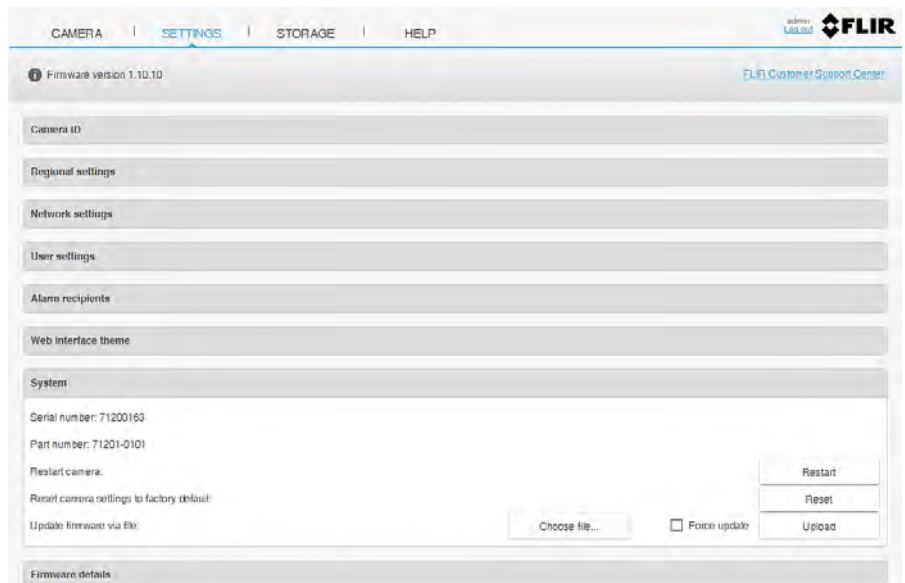

2. To restart the camera, do the following:
  - 2.1. Click the *Restart* button. This displays a dialog box.
  - 2.2. In the dialog box, click the *OK* button.
3. To reset the camera settings to the factory default, do the following:
  - 3.1. Click the *Restart* button. This displays a dialog box.
  - 3.2. In the dialog box, click the *OK* button. This will affect all camera settings, including regional settings. Saved images will not be affected. The camera will restart.
4. To update the firmware via a file, do the following:
  - 4.1. Click the *Choose file...* button. This opens the standard Windows Open dialog box.
  - 4.2. Browse to the location of the firmware file. Select the file and click the *Open* button.
  - 4.3. By selecting the check box *Force update*, any error messages will be overridden and the update will be installed even if you, for example, try to install an older version of the firmware. Only select the check box if you know what you are doing.
  - 4.4. Click the *Upload* button.

### 14.4.8 Firmware details

#### 14.4.8.1 General

The *Firmware details* section displays information about the camera firmware: Package, OS, Kernel, Boot, and Configuration.

### 14.4.8.2 Procedure

To view the firmware details, follow this procedure:

1. Click on *Firmware details*. This displays information about the camera firmware.



## 14.5 Storage tab

### 14.5.1 General

Under the *Storage* tab it is possible to view and manage saved images and videos from alarms and snapshots.

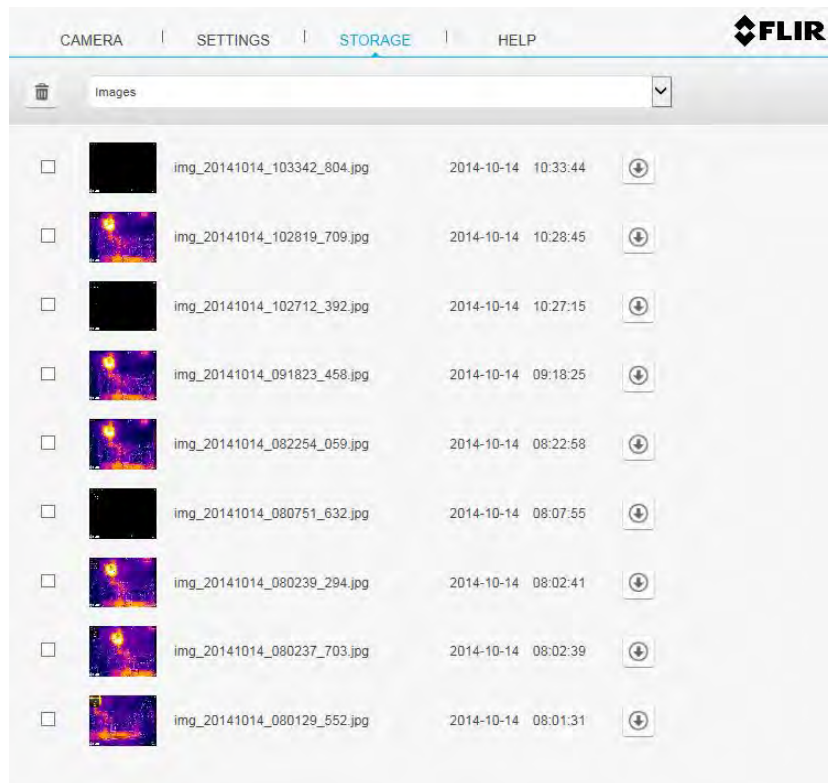

### 14.5.2 Managing images

To view and manage image files, follow this procedure:

1. From the upper list box, select *Images*.
2. To display a preview of an image, click the thumbnail or the filename of the image.

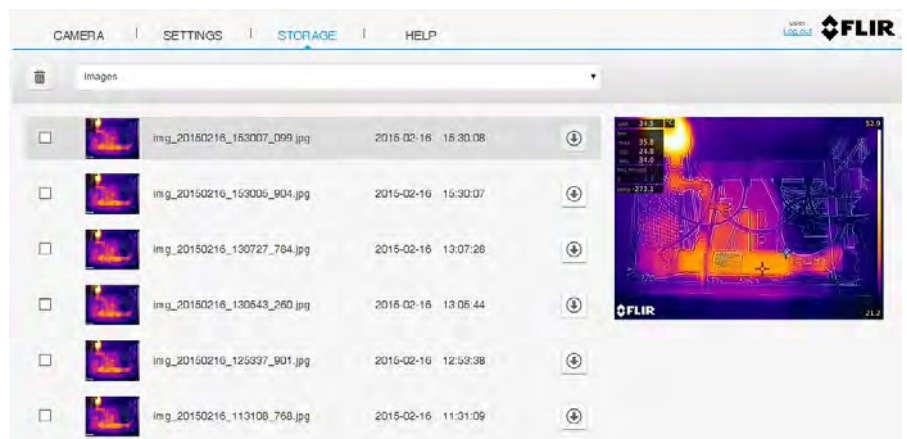

3. To download an image, click the *Download* icon to the right of the image.

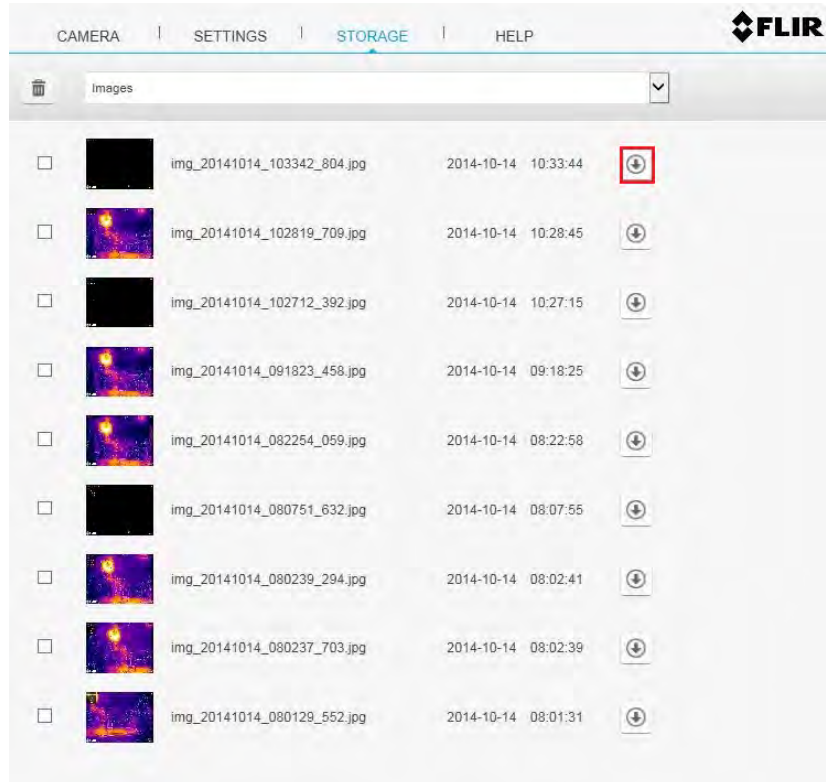

4. To delete one or more image files, do the following:

- 4.1. Select the check box(es) to the left of the image thumbnail(s).
- 4.2. Click the *Delete* icon.

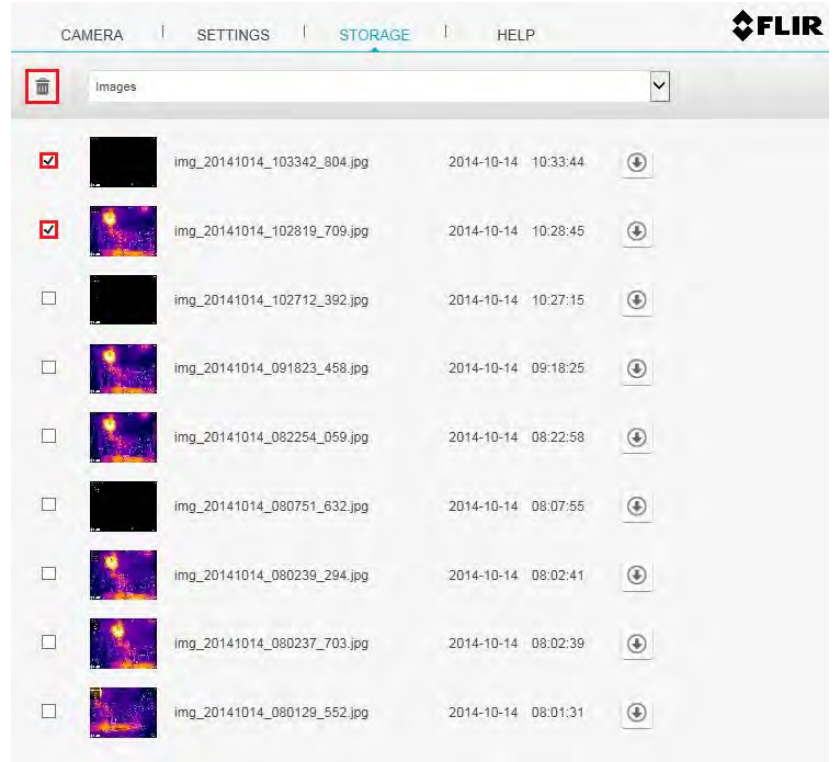



### 14.5.3 Managing videos

To view and manage video files, follow this procedure:

1. From the upper list box, select *Videos*.
2. To download a video, click the *Download* icon to the right of the video.



3. To delete one or more video files, do the following:
  - 3.1. Select the check box(es) to the left of the video thumbnail(s).
  - 3.2. Click the *Delete* icon.

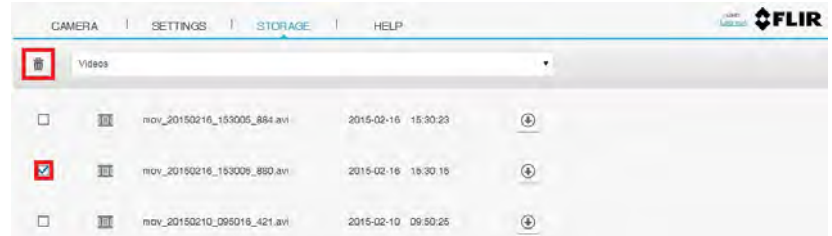



# Software supporting FLIR AX series cameras

The following table explains which software supports FLIR AX series cameras:

Software	Support	Comment
FLIR IP Config <b>Note</b> The FLIR IP Config version must be 1.9 or later.	Yes	<ul style="list-style-type: none"> <li>• Detecting FLIR AX series cameras on the network.</li> <li>• Assigning IP addresses.</li> <li>• Accessing the built-in camera web server.</li> </ul>
Camera web server	Yes	Configuration and setup of analysis and alarms.
FLIR Tools/Tools+	No	—
FLIR IR Monitor	No	—
EthernetIP & Modbus TCP	Yes	Connecting to a PLC for readout of analysis and alarms.
Pleora Ebus SDK	No	—
FLIR GEV Demo	No	—
ThermoVision System Developers Kit	No	—
ThermoVision LabVIEW Digital Toolkit	No	—

## 16.1 Installation

### 16.1.1 General information

#### 16.1.1.1 Explanation

**The following programs are included on the application CD:**

- FLIR IP Config: A setup and configuration program for detecting and finding FLIR automation and science cameras on a network and automatically assigning or manually setting IP addresses.
- FLIR IR Monitor: A program for controlling FLIR automation and science cameras on a network. You typically use FLIR IR Monitor to change camera settings, lay out measurement tools on the screen, set up alarms, etc.
- FLIR IR Camera Player: A PC-based remote control and video player for infrared cameras from FLIR Systems.
- A link to a web installation of FLIR Axxx Control & Image Interfaces: An installation that includes Interface Control Documents (ICDs), user documentation, and C-code examples. We recommend that you read through the documentation.

#### 16.1.1.2 Default installation paths

- C:\Program Files\FLIR Systems\FLIR IP Config
- C:\Program Files\FLIR Systems\FLIR IR Monitor
- C:\Program Files\FLIR Systems\FLIR IR Camera Player
- C:\Program Files\FLIR Systems\FLIR Axxx Control & Image Interfaces

**Note** Functionality in the PC programs is dependent on the camera model.

### 16.1.2 System requirements

#### 16.1.2.1 Operating system

- Microsoft Windows XP Professional, with Service Pack 2 (SP2).
- Microsoft Windows Vista Ultimate 32-bit.
- Microsoft Windows 7, 32-bit and 64-bit.

#### 16.1.2.2 Hardware

- Personal computer with a 2 GHz 32-bit or 64-bit processor.
- 1 GB of RAM or more.
- 20 GB of hard disk space.
- Super VGA (1024 × 768) or higher-resolution monitor.
- Support for DirectX 9 graphics with:
  - WDDM driver
  - 128 MB of graphics memory (minimum)
  - Pixel Shader 2.0 (in hardware)
  - 32 bits per pixel.
- DVD-ROM drive.
- Audio output.
- Keyboard and Microsoft mouse, or a compatible pointing device.

#### 16.1.2.3 Software

Microsoft Internet Explorer 6 or later.

#### 16.1.2.4 More information

For specific information about system requirements for the operating systems mentioned above, please visit: <http://www.microsoft.com/windows/>.

### 16.1.3 Installation

#### 16.1.3.1 General

Last-minute changes and other important information can be found in the read-me file on the CD-ROM. We recommend that you read this file before you install the programs.

#### Note

- If you experience problems during the installation, visit our Customer Help at <http://support.flir.com>.
- You must be an Administrator or a user with Administrative Rights to install the programs.
- A complete installation consists of several subinstallations, some of which are from third-party vendors. Do not abort these subinstallations, as they are needed for the complete installation.
- A complete installation can take up to 10 minutes to complete.

#### 16.1.3.2 Procedure

##### Follow this procedure:

1. Close down all applications.
2. Insert the ThermoVision System Tools & Utilities CD-ROM into the CD drive on the computer. The installation should start automatically.

Should the installation not start automatically, start Windows Explorer and double-click SETUP.HTM on the CD-ROM.

3. Click Install FLIR IP Config.
4. Follow the on-screen instructions.

## 16.2 Detecting cameras in a network

### 16.2.1 General

With FLIR IP Config, you can do the following:

- Automatically assign or manually set the IP address for a camera.
- Set the subnet mask for a camera.
- Set the default gateway for a camera.
- Go to the camera's web interface (dependent on the camera model). For procedures related to the user web, refer to Publ. No. T559500, FLIR Camera Web Interface User's manual.

### 16.2.2 Modifying IP Address settings

##### Follow this procedure:

1. On the *Start* menu, click FLIR IP Config (*Start > Programs > FLIR Systems > FLIR IP Config*). This will display the FLIR IP Config main window:

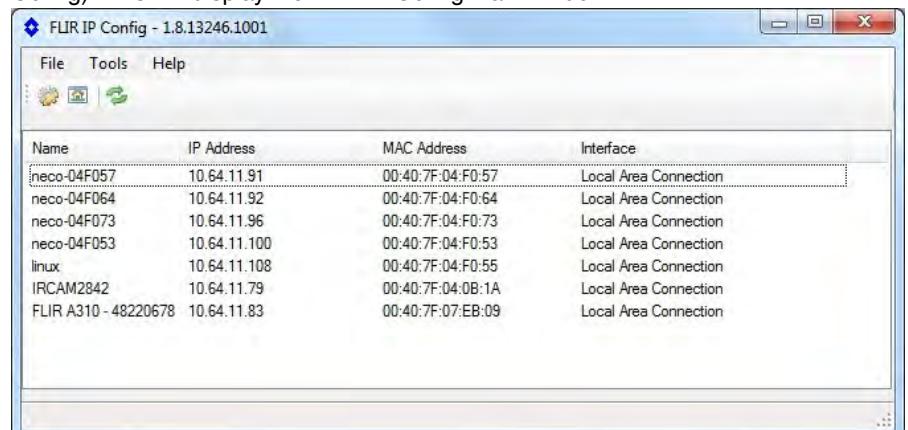

2. In the list of detected cameras, do the following:

- Right-click one camera and select *Modify*.
- Select one camera and click  on the toolbar. This will display the *IP Address Settings* dialog box:



3. In the *IP Address Settings* dialog box, you can enter new values for one or more of the following parameters:

- *IP address*.
- *Subnet mask*.
- *Default gateway*.

4. Click *OK*.

#### Note

- A network switch may have the spanning tree algorithm (STA) enabled. The STA blocks all packets from a new connected port for a “forward delay” second. This forward delay is usually between 15 and 45 seconds. A GigE Vision device complying with the GigE Vision standard will attempt for only 6 seconds ( $\pm 2$  seconds) to get its IP address through DHCP before using the local link address (LLA = 169.254.x.x) to get its IP address. The DHCP process for a GigE Vision-compliant device may therefore fail if connected to a switch which has STA enabled. To prevent this from happening, the forward delay should be set to 4 seconds, or the STA disabled for the switch port.
- If you change the IP address, you need to restart the camera (dependent on the camera model).

### 16.2.3 Changing the language

#### Follow this procedure:

1. On the *Start* menu, click *FLIR IP Config* (*Start > Programs > FLIR Systems > FLIR IP Config*).
2. On the main menu bar, click *Options*. This will display the *Options* dialog box:

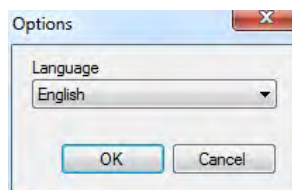

3. To change the language, select a new language in the *Language* box.
4. Click *OK*.

**16.3 Program reference section**

**16.3.1 Main menu bar**

**Table 16.1** The File menu

<i>Exit</i>	By clicking <i>Exit</i> , the program closes down.
-------------	--

**Table 16.2** The Tools menu

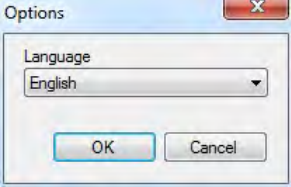

<i>Options</i>	<p>By clicking <i>Options</i>, the <i>Options</i> dialog box will be displayed. In this dialog box the language can be changed.</p> 
----------------	---

**Table 16.3** The Help menu

<i>Manual as HTML Help</i>	By clicking <i>Manual as HTML Help</i> , the user documentation will be displayed as a Microsoft HTML help file.
<i>Manual as Adobe PDF file</i>	By clicking <i>Manual as Adobe PDF file</i> , the user documentation will be displayed as an Adobe Acrobat PDF file.

**16.3.2 Main toolbar**

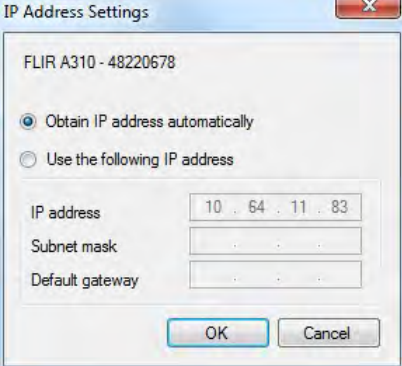
**Table 16.1** The main toolbar

	<p>By clicking this toolbar button, a dialog box will be displayed where the IP address, the subnet mask, and the default gateway can be changed. The IP address can also be obtained automatically.</p> 
	By clicking this toolbar button, the camera's web interface will be displayed (dependent on the camera model).
	By clicking this toolbar button, the list of cameras will be refreshed.

### 16.3.3 Right-click menu

**Table 16.1** The right-click menu

<p><i>Modify</i></p>	<p>By clicking <i>Modify</i>, a dialog box will be displayed where the IP address, the subnet mask, and the default gateway can be changed.</p> 
<p><i>Web</i></p>	<p>By clicking <i>Web</i>, the camera's web interface will be displayed (dependent on the camera model).</p>
<p><i>Refresh</i></p>	<p>By clicking <i>Refresh</i>, the list of cameras will be refreshed.</p>

## 16.4 Network troubleshooting

Try one of the following if you experience network problems:

- Reset the modem and unplug and replug the Ethernet cable at both ends.
- Reboot the computer with the cables connected.
- Swap your Ethernet cable with another cable that is either brand new or known to be in working condition.
- Connect your Ethernet cable to a different wall socket. If you are still not able to get online, you are probably experiencing a configuration issue.
- Verify your IP address.
- Disable network bridging.
- Disable your Wi-Fi connectivity (if you use it) to ensure that the wired Ethernet port is open.
- Renew the DHCP license.
- Make sure that the firewall is turned off when you troubleshoot.
- Make sure that your wireless adapter is switched off. If not, the search for the camera might only look for a wireless connection.
- Normally a computer will handle both crossed and uncrossed cable types automatically, but for troubleshooting purposes try both or use a switch.
- Turn off any network adapters that are not connected to the camera.
- For troubleshooting purposes, power both the camera and the computer using a mains adapter. Some laptops turn off the network card to save power when using the battery.

If none of these steps help you, contact your ISP.

## 17.1 Online field-of-view calculator

Please visit <http://support.flir.com> and click the photo of the camera series for field-of-view tables for all lens-camera combinations.

## 17.2 Note about technical data

FLIR Systems reserves the right to change specifications at any time without prior notice. Please check <http://support.flir.com> for latest changes.

## 17.3 Note about authoritative versions

The authoritative version of this publication is English. In the event of divergences due to translation errors, the English text has precedence.

Any late changes are first implemented in English.

## 17.4 FLIR AX8 9 Hz

P/N: 71201-0101

Rev.: 36680

<b>General description</b>	
<p>The FLIR AX8 camera/sensor provides an affordable and accurate temperature measurement solution for anyone who needs to solve problems that need built in "smartness" such as analysis, alarm functionality, and autonomous communication using standard protocols. The FLIR AX8 also has all the necessary features and functions to build distributed single- or multi-camera solutions utilizing standard Ethernet hardware and software protocols.</p>	
<p>The FLIR AX8 also has built-in support to connect to industrial control equipment such as PLCs, and allows the sharing of analysis and alarm results and simple control using the Ethernet/IP and Modbus TCP field bus protocols.</p>	
<p>Key features:</p> <ul style="list-style-type: none"> <li>• Support for the EthernetIP field bus protocol (analyze, alarm, and simple camera control).</li> <li>• Support for the Modbus TCP field bus protocol (analyze, alarm, and simple camera control).</li> <li>• Built-in analysis functionality.</li> <li>• Alarm functionality, as a function of analysis and more.</li> <li>• Built-in web server for control and set up.</li> <li>• MJPEG, MPEG-4, or H.264 image streaming.</li> <li>• PoE (Power over Ethernet).</li> <li>• General-purpose output.</li> <li>• 100 Mbps Ethernet (100 m cable).</li> <li>• On alarm: file sending (FTP) or e-mail (SMTP) of analysis results or images.</li> </ul>	
<p>Typical applications:</p> <ul style="list-style-type: none"> <li>• Electrical and mechanical condition-monitoring applications where temperature or temperature trends can be an indication of a potential risk of failure.</li> <li>• Simple process control applications.</li> </ul>	
<b>Imaging and optical data</b>	
IR resolution	80 × 60 pixels
Thermal sensitivity/NETD	< 0.10°C @ +30°C (+86°F) / 100 mK
Field of view (FOV)	48° × 37°
Depth of field	0.1 m (0.33 ft.), infinity
Focal length	1.54 mm (0.061 in.)
Spatial resolution (IFOV)	11.1 mrad
F-number	1.1
Image frequency	9 Hz
Focus	Fixed
<b>Detector data</b>	
Detector type	Focal plane array (FPA), uncooled microbolometer
Spectral range	7.5–13 μm
Detector pitch	17 μm
Detector time constant	Typical 12 ms
<b>Visual camera</b>	
Built-in digital camera	640 × 480
Digital camera, FOV	Adapts to the IR lens
Sensitivity	Minimum 10 lux without illuminator



<b>Measurement</b>	
Object temperature range	-10 to +150°C (14 to +302°F)
Accuracy	±2°C (±3.6°F) or ±2% of reading (+10 to +100°C @ +10 to +35°C ambient)
<b>Measurement analysis</b>	
Spotmeter	6
Area	6 boxes with max./min./average
Automatic hot/cold detection	Max./min. temperature value and position shown within box
Measurement presets	Yes
Atmospheric transmission correction	Automatic, based on inputs for distance, atmospheric temperature and relative humidity
Optics transmission correction	Automatic, based on signals from internal sensors
Emissivity correction	Variable from 0.01 to 1.0
Reflected apparent temperature correction	Automatic, based on input of reflected temperature
External optics/windows correction	Automatic, based on input of optics/window transmission and temperature
Measurement corrections	Global object parameters
<b>Alarm</b>	
Alarm functions	Automatic alarms on any selected measurement function. A maximum of 5 alarms can be set.
Alarm output	Digital out, store image, file sending (FTP), email (SMTP), notification
<b>Set-up</b>	
Color palettes	Color palettes (BW, BW inv, Iron, Rain)
Set-up commands	Date/time, Temperature (°C/°F)
Web interface	Yes
<b>Storage of images</b>	
Storage media	Built-in memory for image storage
Image storage mode	IR, visual, MSX
File formats	JPEG + FFF
<b>Image streaming</b>	
Image streaming formats	<ul style="list-style-type: none"> <li>• Motion JPEG stream MJPEG Baseline Process Encoder Baseline ISO/IEC 10918-1 JPEG compliance</li> <li>• MPEG stream Stream format MPEG-4 ISO/IEC 14496-2 Simple Profile level 2</li> <li>• H.264 stream Stream format H.264 Baseline Profile level 2.0</li> </ul>
Image streaming resolution	640 × 480
Image modes	<ul style="list-style-type: none"> <li>• Thermal</li> <li>• Visual</li> <li>• MSX</li> </ul>
Automatic image adjustment	Continuous
Multi Spectral Dynamic Imaging (MSX)	IR image with enhanced detail presentation

<b>Ethernet</b>	
Ethernet	Control, result and image
Ethernet, type	100 Mbps
Ethernet, standard	IEEE 802.3
Ethernet, connector type	M12 8-pin X-coded
Ethernet, communication	TCP/IP socket-based FLIR proprietary
Ethernet, video streaming	Yes
Ethernet, power	Power over Ethernet, PoE IEEE 802.3af class 2.
Ethernet, protocols	Ethernet/IP, Modbus TCP, TCP, UDP, SNTP, RTSP, RTP, HTTP, ICMP, IGMP, sftp, SMTP, DHCP, MDNS (Bonjour)
<b>Digital input/output</b>	
Digital input, purpose	NUC, NUC disable, Alarm
Digital input	1 opto-isolated, 10–25 VDC
Digital output, purpose	As function of alarm, output to ext. device (programmatically set)
Digital output	1 opto-isolated, 10–25 VDC, max. 100 mA
Digital I/O, isolation voltage	500 VRMS
Digital I/O, supply voltage	10-25 VDC, max. 200 mA
Digital I/O, connector type	M12 8-pin A-coded (shared with ext. power)
<b>Power system</b>	
External power operation	12/24 VDC, 2 W continuously/ 4.7 W absolute max
External power, connector type	M12 8-pin A-coded (Shared with digital I/O)
Voltage	Allowed range 10.8–30 VDC
Power supply rating	Class 2 / LPS
<b>Environmental data</b>	
Operating temperature range	–0°C to +50°C (+32°F to +122°F)
Storage temperature range	–40°C to +70°C (–40°F to +158°F) according to IEC 68-2-1 and IEC 68-2-2
Humidity (operating and storage)	IEC 60068-2-30/24 h 95% relative humidity +25°C to +40°C (+77°F to +104°F)/ 2 cycles
EMC	<ul style="list-style-type: none"> <li>EN 61000-6-2:2001 (Immunity)</li> <li>EN 61000-6-3:2001 (Emission)</li> <li>FCC 47 CFR Part 15 Class B (Emission)</li> </ul>
Encapsulation	IP 67 (IEC 60529)
Bump	25 g (IEC 60068-2-29)
Vibration	2 g (IEC 60068-2-6)
<b>Physical data</b>	
Weight	0.125 kg (0.28 lb.)
Camera size (L x W x H)	<ul style="list-style-type: none"> <li>54 x 25 x 79 mm (2.1 x 1 x 3.1 in.) without connectors</li> <li>54 x 25 x 95 mm (2.1 x 1 x 3.7 in.) with connectors</li> </ul>
Base mounting	4x mounting hole depth max 4.8 mm for screw type Delta PT 22 (ø2.2 mm)
Housing material	PA6 with 30% GF (glass fiber reinforced)

Shipping information	
Packaging, type	Cardboard box
List of contents	<ul style="list-style-type: none"> <li>• Infrared camera with lens</li> <li>• Cardboard box</li> <li>• Printed documentation</li> </ul>
Packaging, weight	0.48 kg (1.06 lb.)
Packaging, size	210 × 142 × 70 mm (8.27 × 5.59 × 2.76 in.)
EAN-13	4743254001725
UPC-12	845188009373
Country of origin	Estonia

#### Supplies & accessories:

- T128391ACC; Cable, M12 to pigtail
- T198821; Cooling bracket
- T129259ACC; Cable M12 to pigtail, 10 m
- T129258ACC; Cable M12 to pigtail, 5 m
- T129257ACC; Ethernet cable M12 to RJ45, 10 m
- T128390ACC; Ethernet cable M12 to RJ45, 2 m
- T129256ACC; Ethernet cable M12 to RJ45, 5 m
- 71200-0002; FLIR AX8 accessory starter kit
- T199163; Front mounting plate kit (incl. cooling bracket)
- T199342; One-ball joint mounting bracket kit
- T199343; PoE injector, 12/24 V
- T199019; PoE injector, incl. cables
- T128775ACC; Rear mounting plate kit
- T199341; Two-ball joint mounting bracket kit

In order to obtain reliable measurement results, the following minimum measurement areas apply.

<b>Distance</b>	<b>Instantaneous field of view (IFOV) (radians)</b>	<b>Minimum measurement areas</b>
0.3 m (1 ft.)	0.003	2.7 × 2.7 cm (1.1 × 1.1 in.)
0.5 m (1.6 ft.)	0.0055	4.95 × 4.95 cm (1.9 × 1.9 in.)
1 m (3.3 ft.)	0.011	9.9 × 9.9 cm (3.9 × 3.9 in.)
2 m (6.6 ft.)	0.022	19.8 × 19.8 cm (7.8 × 7.8 in.)
3 m (9.8 ft.)	0.033	29.7 × 29.7 cm (11.7 × 11.7 in.)



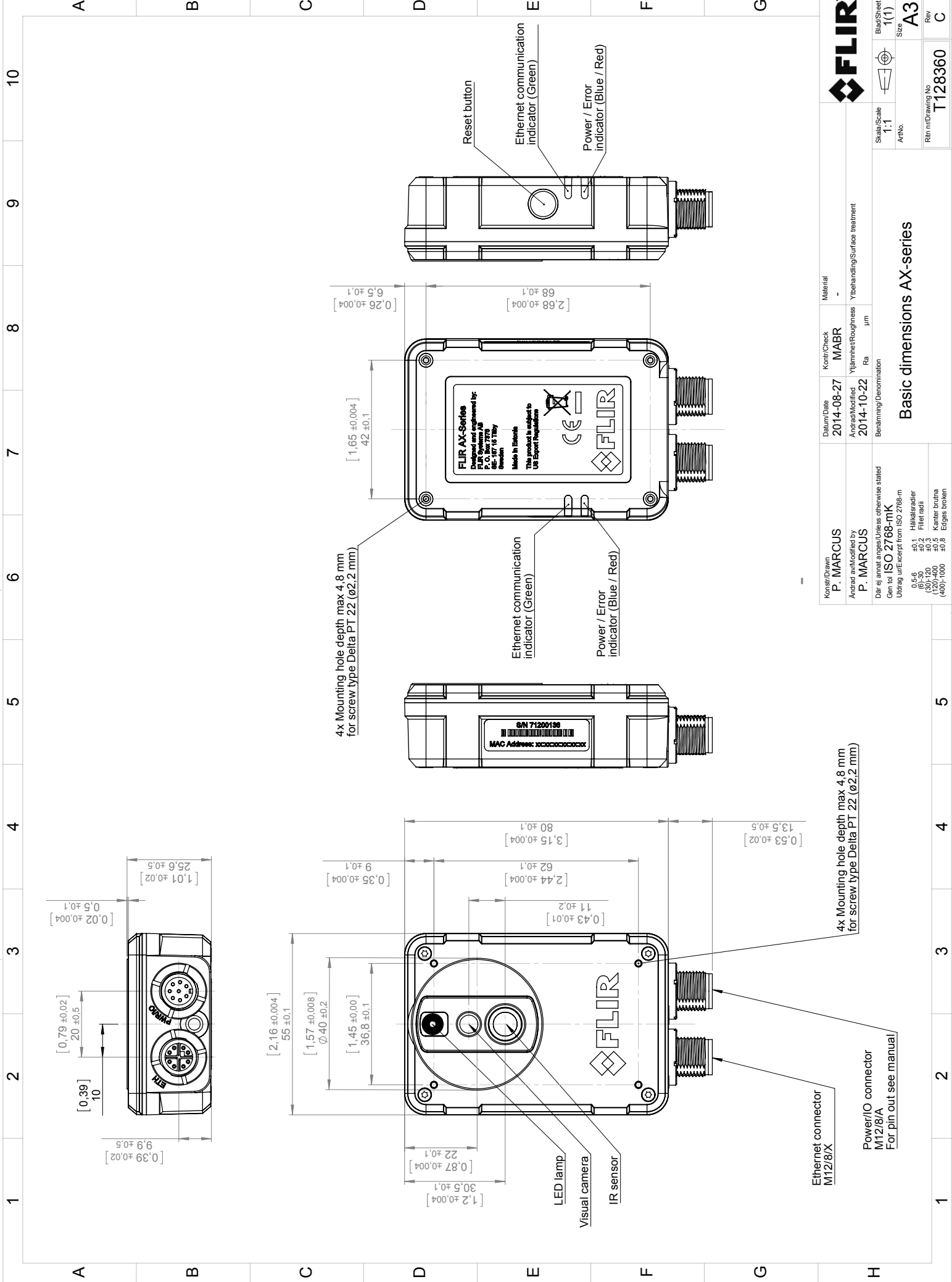

<b>FLIR</b>		Material	
Konstr/Drawn <b>P. MARCUS</b>		Kontr/Check <b>MABR</b>	Material -
Datum/Date <b>2014-08-27</b>		Ytbehandling/Surface treatment	
Ändrad/Modified <b>2014-10-22</b>		Ytämhet/Roughness Ra $\mu\text{m}$	
Benämning/Denomination <b>Basic dimensions AX-series</b>		Skala/Scale 1:1	
Dir ej ansvarig om inte annat anges/Unless otherwise stated <b>Gen tol ISO 2768-mK</b>		Blad/Sheet 1(1)	
Utdrag ur ISO 2768-mK 0,5-6 ±0,1 Hållisradier (6)-30 ±0,2 Fillet radii (120)-400 ±0,5 Kanter brutna (400)-1000 ±0,8 Edges broken		A3 Size	
Rit nr/Drawing No <b>T128360</b>		Rev C	

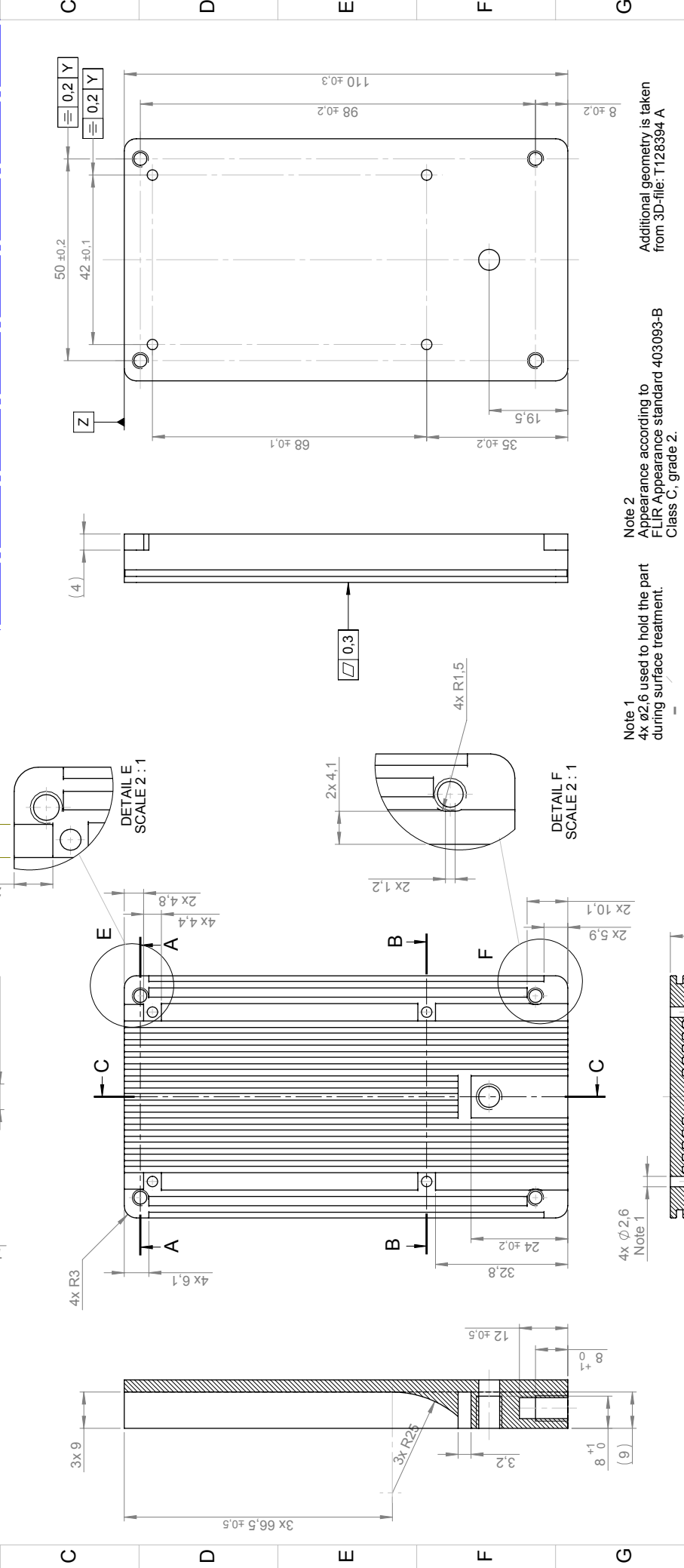
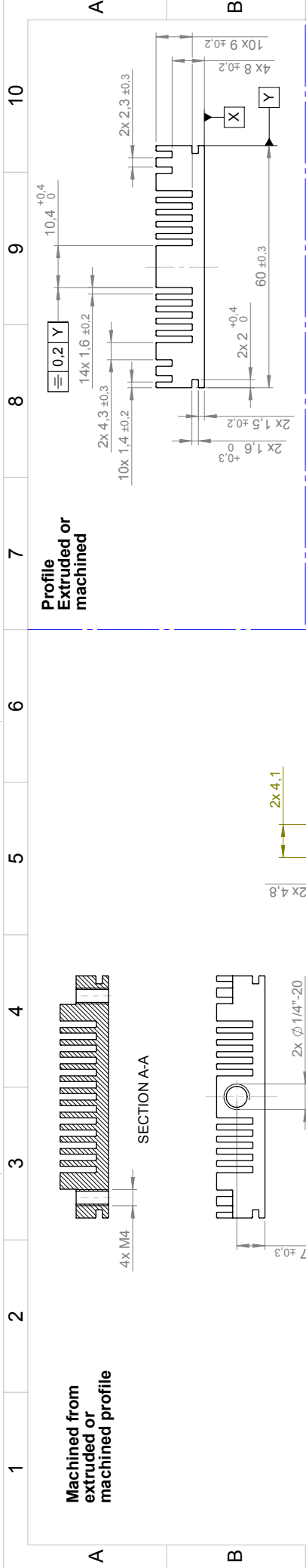

Konstr/Drawn <b>P. MARCUS</b>		Datum/Date 2014-09-18		Kontr/Check <b>JAMA</b>		Material <b>EN AW-6262 R</b>	
Andrad av/Modified by <b>P. MARCUS</b>		Andrad/Modified 2015-03-10		Ytlinnelse/Roughness Ra 3.2 $\mu\text{m}$		Ytbehandling/Surface treatment <b>Anodized colorless matt</b>	
Där ej annat anges/Unless otherwise stated Gen tof ISO 2768-mK		Benämning/Denomination <b>Bracket cooling</b>		Skala/Scale <b>1:1</b>		BlackSheet <b>1(1)</b>	
0.5-6 Hållarsradier (6)-30 Fillet radii (120)-400 Kantsradier (-400)-1000 Kantsradier		0.1-0.3 0.1-0.3 0.1-0.3		Rlin nr/Drawing No <b>T128394</b>		Rev <b>A</b>	



**Note 1**  
 4x  $\phi 2.6$  used to hold the part during surface treatment.

**Note 2**  
 Appearance according to FLIR Appearance standard 403093-B Class C, grade 2.

Additional geometry is taken from 3D-file: T128394 A

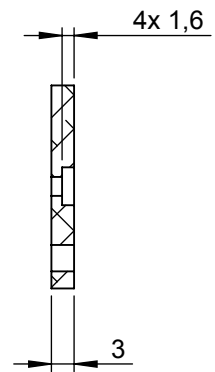
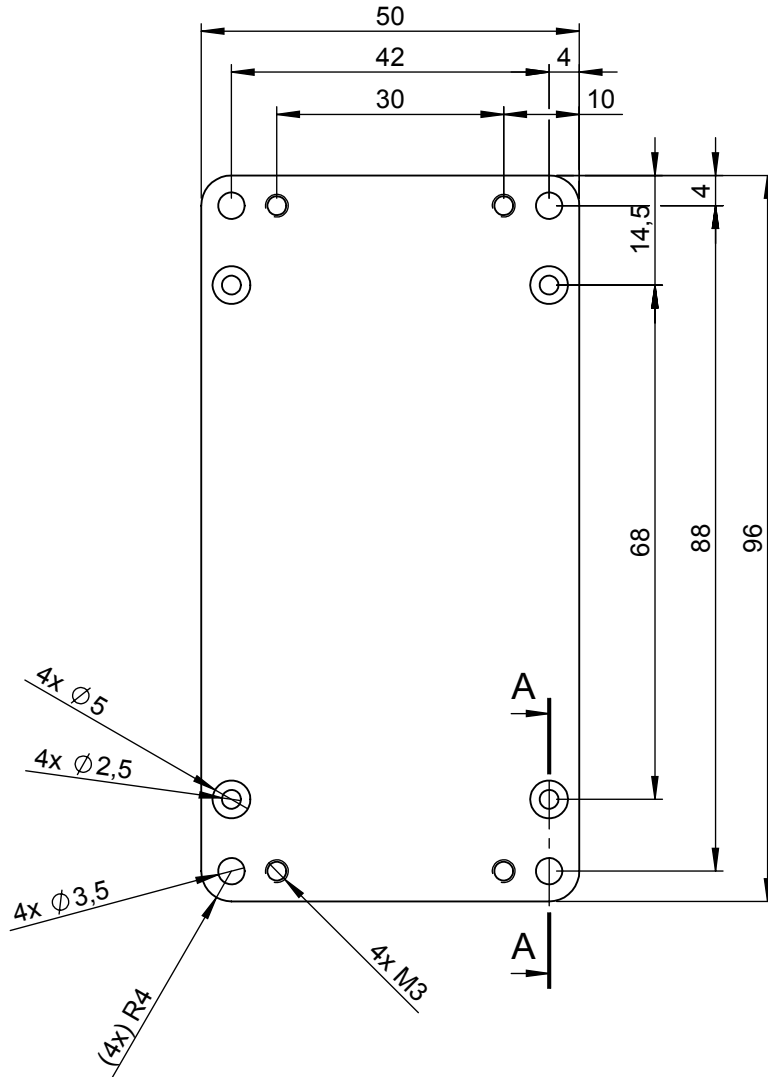

SECTION A-A

Konstr/Drawn <b>J. MÄKINEN</b>	Datum/Date <b>2015-03-06</b>	Kontr/Check <b>HAOS</b>	Material <b>EN AW-5052 or EN AW-5754</b>			
Ändrad av/Modified by <b>J. MÄKINEN</b>	Ändrad/Modified <b>2015-05-21</b>	Ytjämnhet/Roughness Ra      µm	Ytbehandling/Surface treatment			
Där ej annat anges/Unless otherwise stated Gen tol <b>ISO 2768-mK</b> Utdrag ur/Excerpt from ISO 2768-m	Benämning/Denomination <b>Plate mounting rear</b>			Skala/Scale <b>1:1</b>		Blad/Sheet <b>1(1)</b>
0,5-6 ±0,1 Hålkålsradier (6)-30 ±0,2 Fillet radii (30)-120 ±0,3 (120)-400 ±0,5 Kanter brutna (400)-1000 ±0,8 Edges broken				Art.No.	Size <b>A4</b>	
				Ritn nr/Drawing No <b>T128775</b>	Rev <b>A</b>	



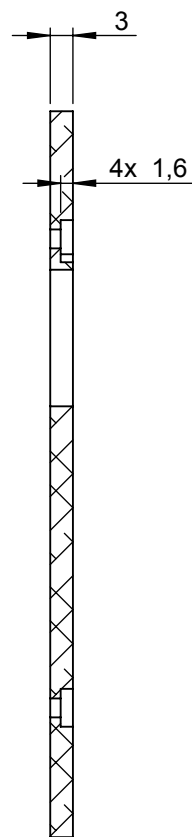
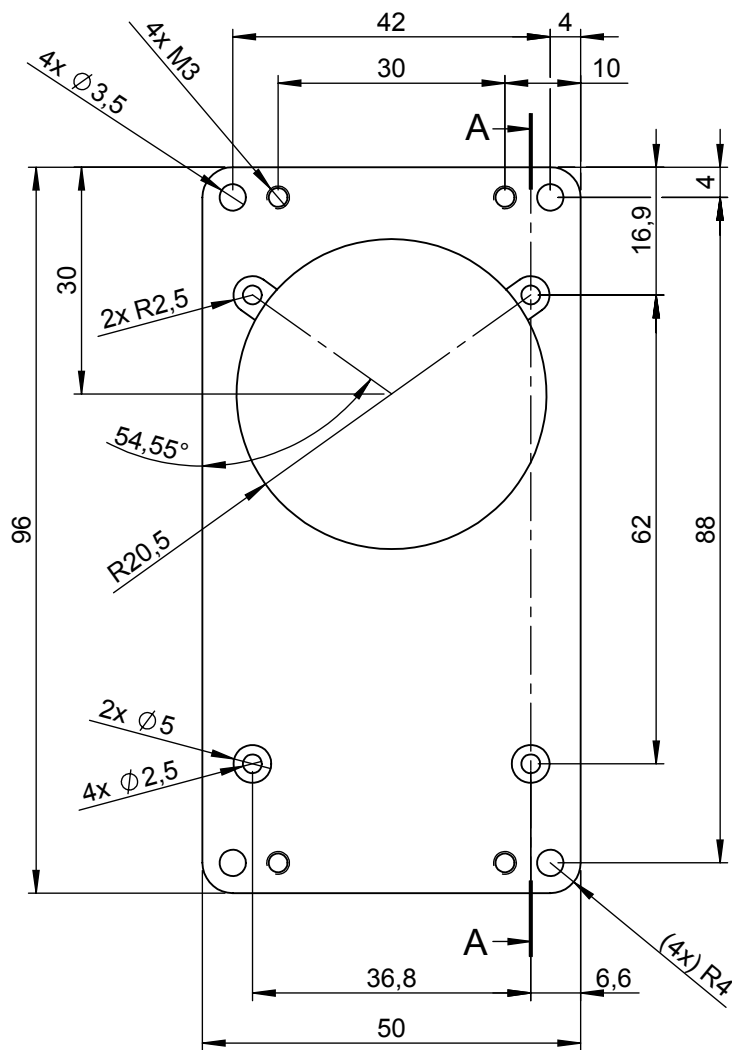

SECTION A-A

Konstr/Drawn <b>J. MÄKINEN</b>	Datum/Date <b>2015-03-06</b>	Kontr/Check <b>HAOS</b>	Material <b>EN AW-5052 or EN AW-5754</b>	
Ändrad av/Modified by <b>J. MÄKINEN</b>	Ändrad/Modified <b>2015-05-21</b>	Ytjämnhet/Roughness Ra      µm	Ytbehandling/Surface treatment	
Där ej annat anges/Unless otherwise stated Gen tol <b>ISO 2768-mK</b> Utdrag ur/Excerpt from ISO 2768-m	Benämning/Denomination <b>Plate mounting front</b>		Skala/Scale <b>1:1</b>	Blad/Sheet <b>1(1)</b>
0,5-6 ±0,1 Hålkälsradier (6)-30 ±0,2 Fillet radii (30)-120 ±0,3 (120)-400 ±0,5 Kanter brutna (400)-1000 ±0,8 Edges broken			Art.No.	Size <b>A4</b>
			Ritn nr/Drawing No <b>T128774</b>	Rev <b>A</b>

---

**Note** The original size of the drilling templates is A4 (210 × 297 mm (8.27 × 11.69 in.)) and they must be printed at that size to work as templates.

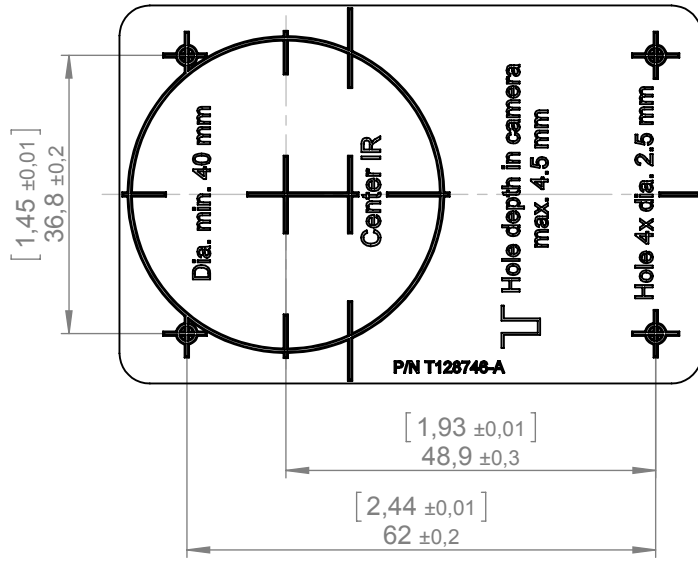

Scale 1:1

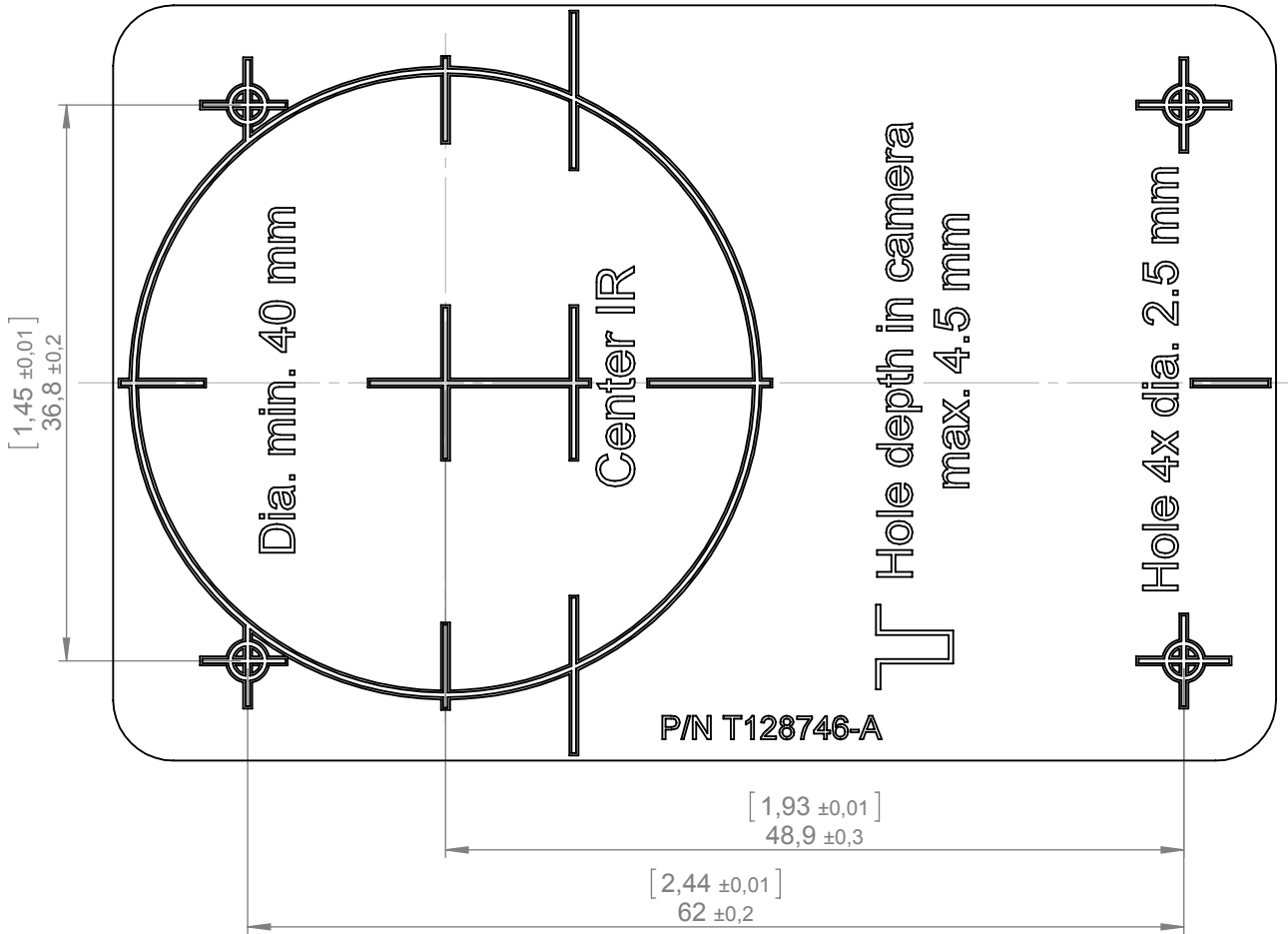

Scale 2:1

Konstr/Drawn <b>P. MARCUS</b>	Datum/Date <b>2014-10-06</b>	Kontr/Check <b>JAMA</b>	Material <b>Note 1</b>	
Ändrad av/Modified by <b>P. MARCUS</b>	Ändrad/Modified <b>2015-03-04</b>	Ytjämnhet/Roughness Ra      μm	Ytbehandling/Surface treatment	
Där ej annat anges/Unless otherwise stated Gen tol <b>ISO 2768-mK</b> Utdrag ur/Excerpt from ISO 2768-m	Benämning/Denomination <b>Drilling template front</b>		Skala/Scale <b>2:1</b>	Blad/Sheet <b>2(2)</b>
0,5-6      ±0,1      Hålkårsradier (6)-30    ±0,2      Fillet radii (30)-120 ±0,3 (120)-400 ±0,5      Kanter brutna (400)-1000 ±0,8      Edges broken			Art.No.	Size <b>A4</b>
			Ritn nr/Drawing No <b>T128746</b>	Rev <b>A</b>

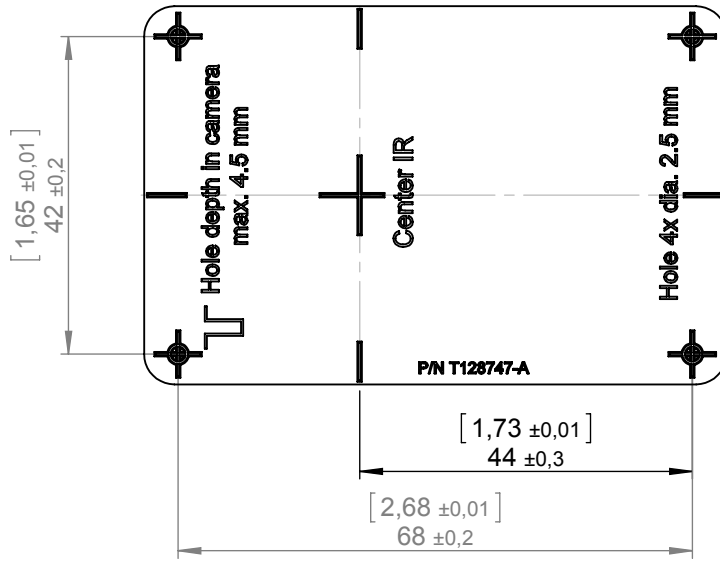

Scale 1:1

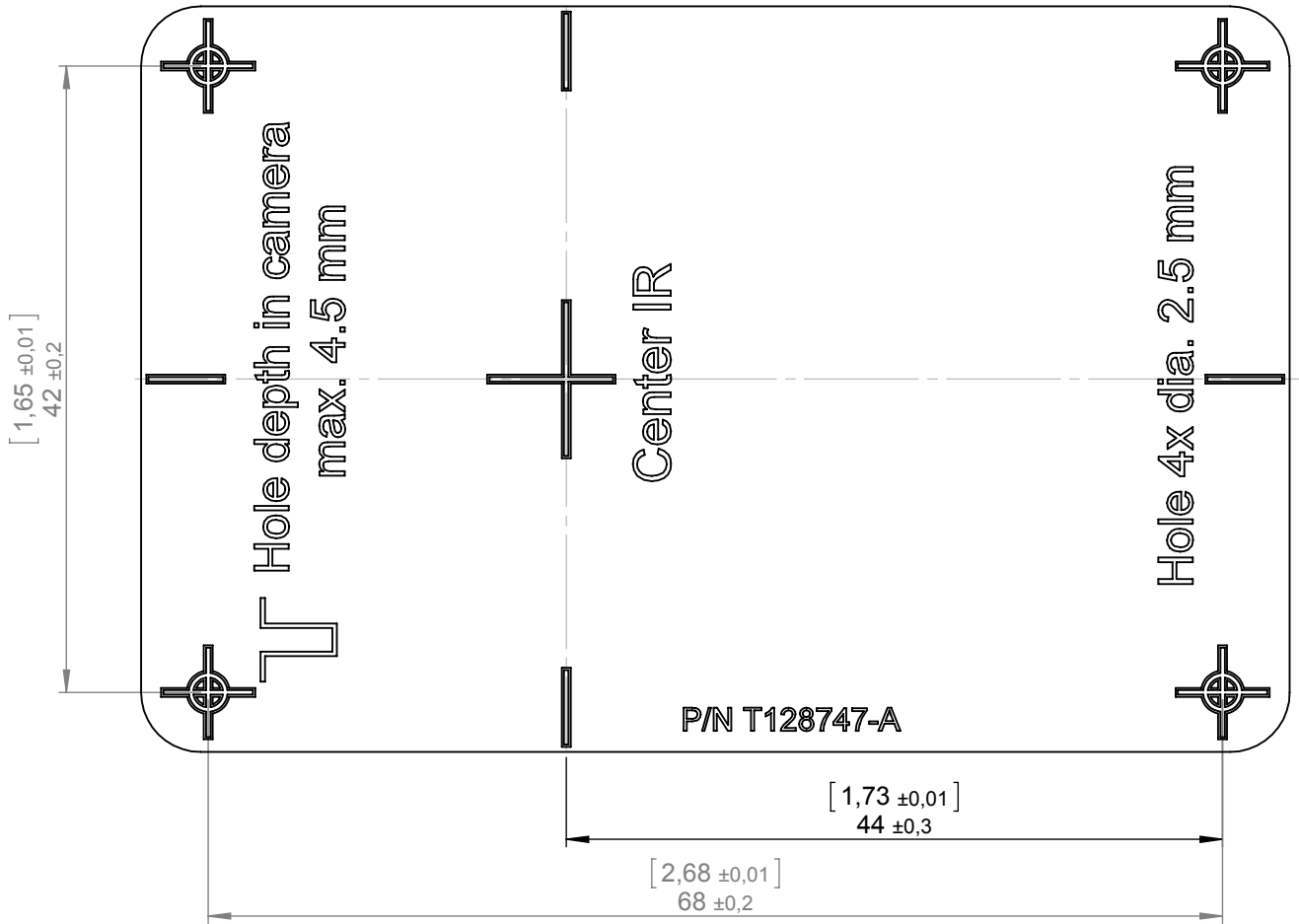

Scale 2:1

Konstr/Drawn <b>P. MARCUS</b>	Datum/Date <b>2014-10-06</b>	Kontr/Check <b>JAMA</b>	Material <b>Note 1</b>	
Ändrad av/Modified by <b>P. MARCUS</b>	Ändrad/Modified <b>2015-03-04</b>	Ytjämnhet/Roughness Ra      μm	Ytbehandling/Surface treatment	
Där ej annat anges/Unless otherwise stated Gen tol <b>ISO 2768-mK</b> Utdrag ur/Excerpt from ISO 2768-m	Benämning/Denomination <b>Drilling template rear</b>			Skala/Scale <b>2:1</b>
0,5-6      ±0,1      Hålkälsradier (6)-30    ±0,2      Fillet radii (30)-120 ±0,3 (120)-400 ±0,5      Kanter brutna (400)-1000 ±0,8      Edges broken				Blad/Sheet <b>2(2)</b>
				Art.No. <b>T128747</b>
				Size <b>A4</b>
				Rev <b>A</b>



## CE Declaration of Conformity

This is to certify that the System listed below have been designed and manufactured to meet the requirements, as applicable, of the following EU-Directives and corresponding harmonising standards. The systems consequently meet the requirements for the CE-mark.

Directives:

**Directive 2004/108/EC;    Electromagnetic Compatibility**

Standards:

**Information technology:    EN 55022                      Radio disturbance characteristics-  
(AC:2011)**

**Information technology:    EN 55024                      Immunity characteristics-  
(CISPR 24:2010)**

Additional standards:

**Emission:                      EN 61000-6-3;    Electro magnetic Compatibility  
Generic standards - Emission**

**Immunity:                      EN 61000-6-2;    Electro magnetic Compatibility;  
Generic standards - Immunity**

System:                              **FLIR Ax8-series**

FLIR Systems AB  
Quality Assurance



Björn Svensson  
Director



**RoHS**  
**IP67**

REV.	DESCRIPTION	DATE
A	ISSUE	Dec/23/2013
B	Modify the wire diagram.	Dec/25/2013
C	Modify M12 Pin Assignment.	Dec/25/2013
D	Modify cable length.	Dec/25/2013
D1	Correct key direction.	Jan/22/2014
E	Add note.	Mar/30/2014
F	Modify P/N.	Sep/25/2014
G	Modify connector to shielding type.	Nov/12/2014
G1	Change ring nut to shielding type.	Nov/25/2014

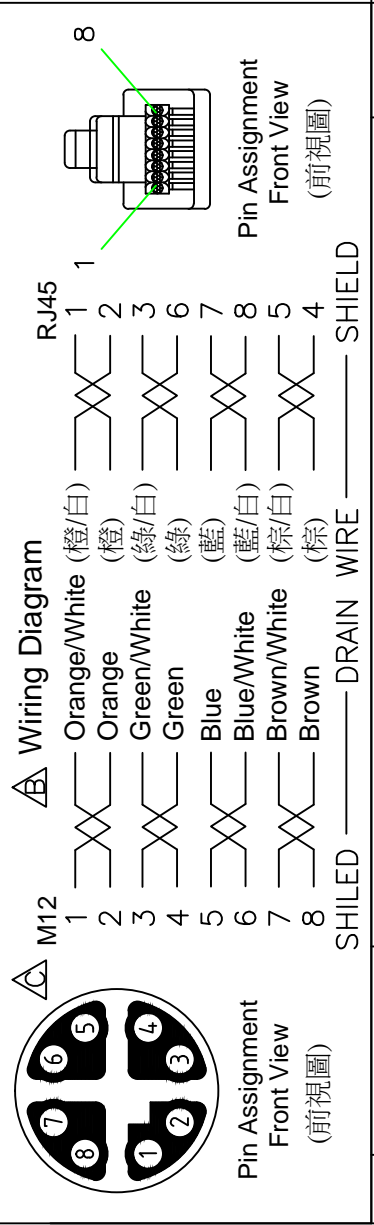
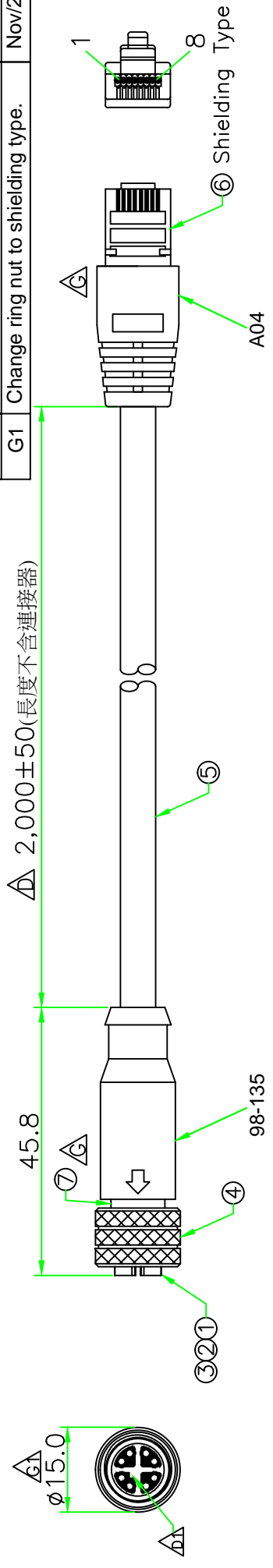

7	SHIELD	Brass, Nickel Plated.	1			
6	RJ45 PLUG	RJ45 8P8C PLUG (shielding type).	1			
5	CABLE	CAT5E FTP 24AWG x 4 PAIR + AL/MY + Drain wire.	1	WAC2B0026		
4	RING NUT	Brass, Nickel Plated.	1	M12S-RN-D985		
3	O-RING	Viton.	1	M12-O-VK		
2	CONTACT	Brass, Female pin, 6 u" Gold plated.	8	AASPF-1008-0.8		
1	CONNECTOR	M12 X-coding Female connector insert. Nylon+GF.	1	M12X-08F		
No.	PART NAME	DESCRIPTION	Q'TY	REMARKS	COLOR	REMARKS

Customer: FLIR	
TITLE	M12 X-Coding Female Molded Cable Assy
UNIT: mm	1:1
SCALE	1:1
UNLESS OTHERWISE SPECIFIED TOLERANCES:	
x ± 0.25	xx ± 0.1
xxx ± 0.05	ANGLE ± 1°X
REV.	SHEET
G1	1/1
P/N:	K129351004
DWG.NC:	T128390
DR.	Stanley
CH.	ERIC
AP.	



RoHS

IP67

REV.	DESCRIPTION	DATE
A	ISSUE	Dec/23/2013
B	Modify cable length.	Dec/25/2013
C	Add note.	Mar/20/2014
D	Modify P/N.	Sep/25/2014
E	Modify connector to shielding type.	Nov/12/2014
E1	Change ring nut to shielding type.	Nov/25/2014

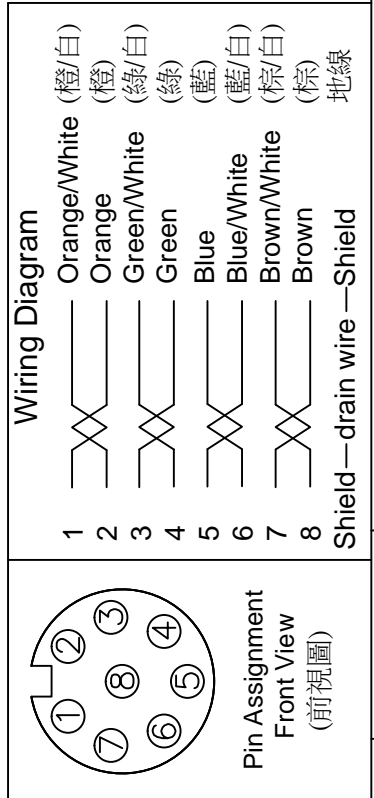
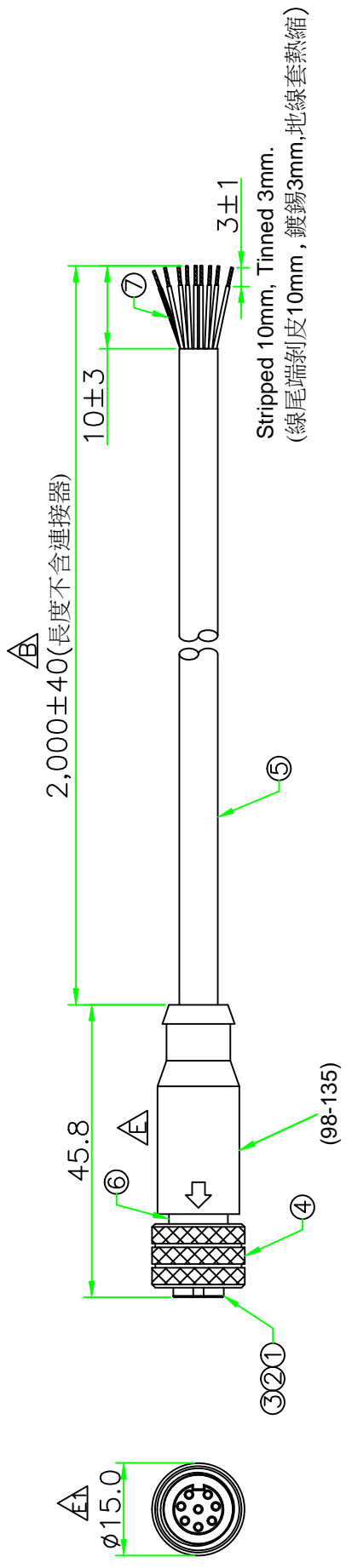

7	TUBE	Heat shrink tube.	BLACK	1	
6	SHIELD	Brass, Nickel Plated. $\Delta$		1	
5	CABLE	CAT5E FTP 24AWG x 4 PAIR + AL/MY + Drain wire.	BLACK	1	WAC2B0026
4	RING NUT	Brass, Nickel Plated.		1	M12S-RN-D985
3	O-RING	Viton.	BLACK	1	M12-O-VK
2	CONTACT	Brass, Female pin, 6 u" Gold plated.		8	AASPF-1008-0.8
1	CONNECTOR	M12 A-coding Female connector insert. Nylon+GF.	BLACK	1	M12A-08F
No.	PART NAME	DESCRIPTION	COLOR	Q'TY	REMARKS

Customer: FLIR

	UNIT: mm	1:1	TITLE	M12 A-Coding 8P Female Molded Cable Assy
	SCALE	1:1	P/N:	K129351003
UNLESS OTHERWISE SPECIFIED TOLERANCES:			DR.	Stanley
x ± 0.25	xx ± 0.1		CH.	ERJC
xxx ± 0.05	ANGLE ± 1°X		DWG. NO:	AP.
REV.	SHEET	1/1		
E1				T128391 $\Delta$

## 23.1 Pin configuration Ethernet X-coded

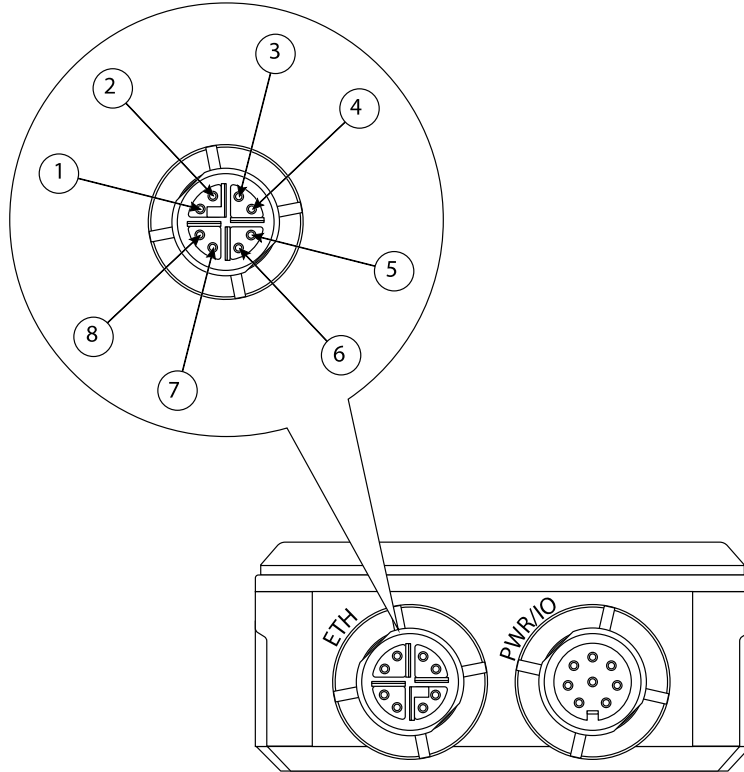

Pin	Configuration
1	TPO+
2	TPO-
3	TPI+
4	TPI-
5	EXT_POE-
6	EXT_POE-
7	EXT_POE+
8	EXT_POE+

### 23.2 Pin configuration power A-coded

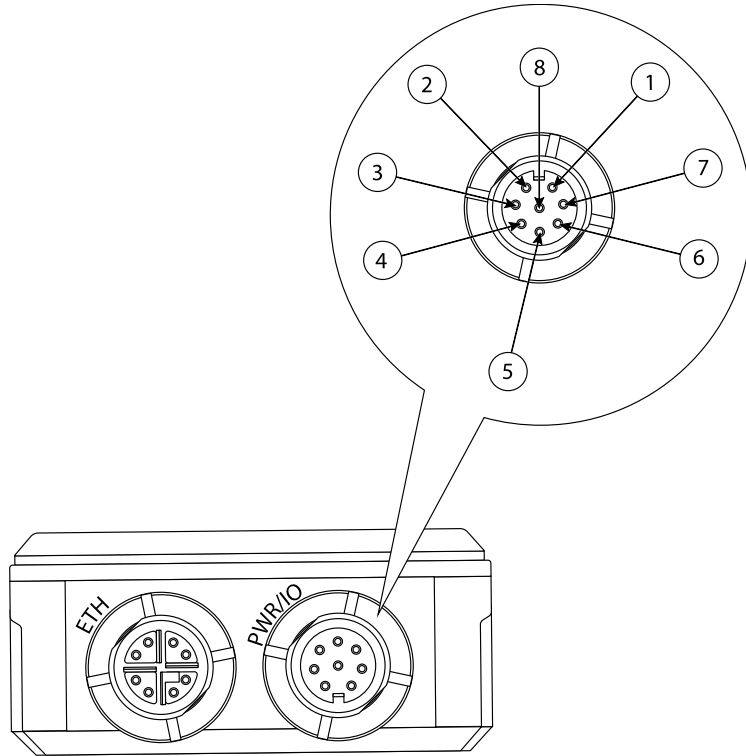

Pin	Configuration	Cable color on cable P/N T128391 (order P/N T128391ACC)
1	EXT_POWER	Orange/white
2	DIGIN	Orange
3	DIG_PWR	Green/white
4	DIG_RTN	Green
5	DIGOUT	Blue
6	Not connected	Blue/white
7	Not connected	Brown/white
8	GND	Brown



# Digital I/O connection diagrams FLIR AX8

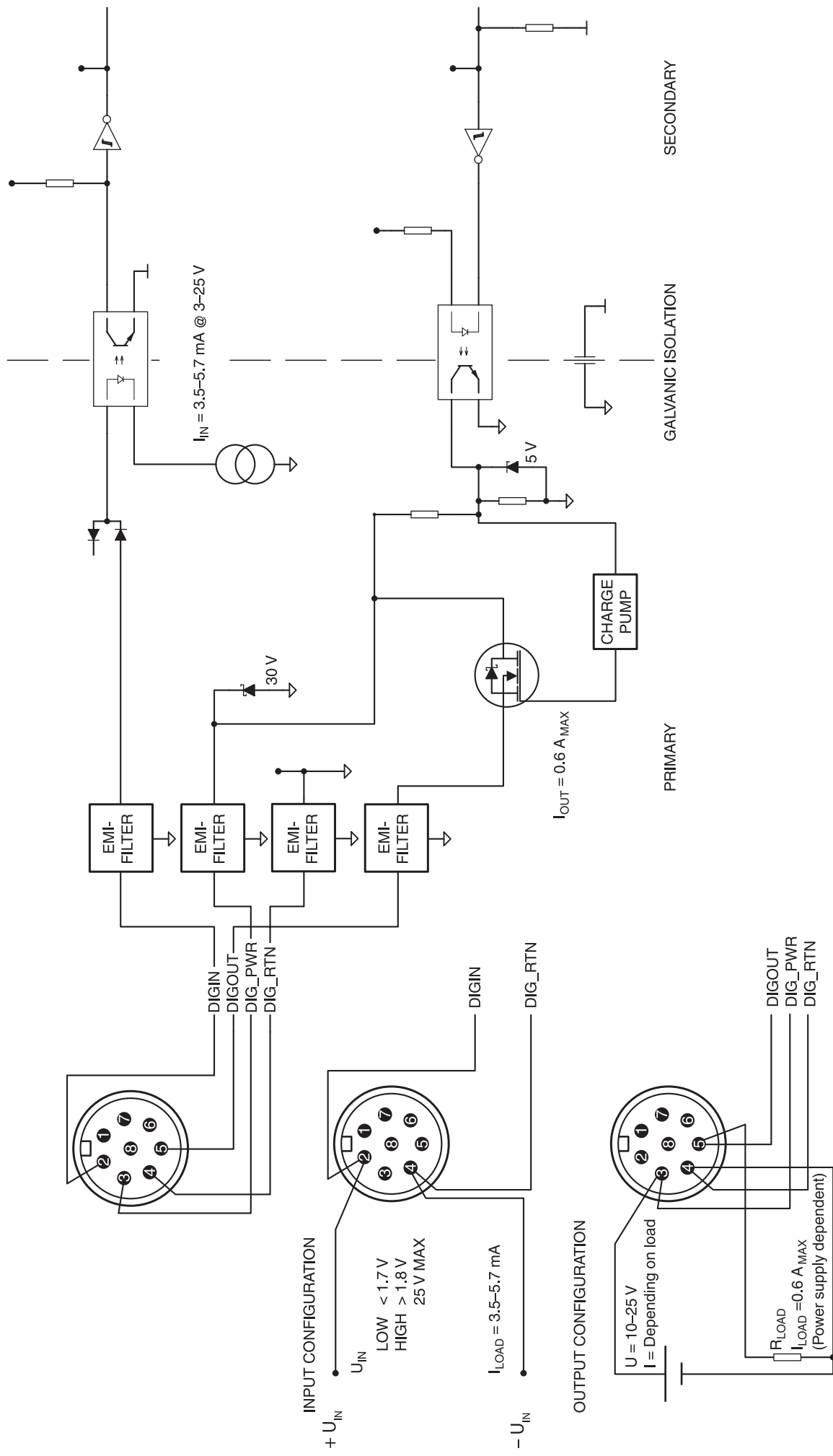

# Indicator LEDs and factory reset button

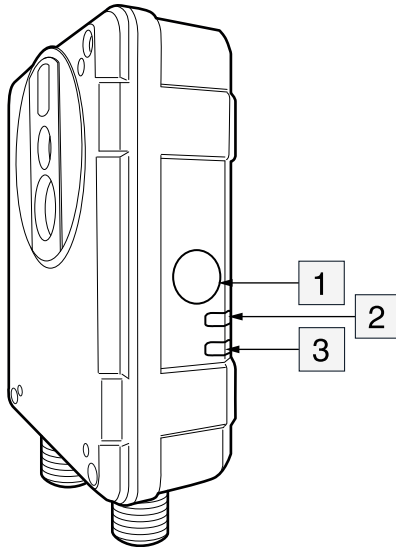

1. Factory reset button.
2. Ethernet communication indicator LED (green).
3. Power/error indicator LED (blue/red).

## 25.1 Power/error indicator LED and factory reset button

**Note** Do not hold down the factory reset button when connecting the camera to power.

Factory reset button depression time period	Indicator LED status	Explanation
> 1 second	The power/error indicator LED displays a continuous red light.	When the factory reset button is released: <ul style="list-style-type: none"> <li>• A factory reset is executed.</li> <li>• The main camera application is restarted.</li> <li>• The indicator LED status resumes the status it had before the button was depressed.</li> </ul>
> 4 seconds	The power/error indicator LED displays a flashing red light.	When the factory reset button is released: <ul style="list-style-type: none"> <li>• A factory reset is executed.</li> <li>• The main camera application is restarted.</li> <li>• The camera's IP settings are reset to the factory defaults (DHCP assigned).</li> <li>• The indicator LED status resumes the status it had before the button was depressed.</li> </ul>
> 10 seconds	The power/error indicator LED displays a rapidly flashing red light.	When the factory reset button is released: <ul style="list-style-type: none"> <li>• A factory reset is executed.</li> <li>• The camera's IP settings are reset to the factory defaults (DHCP assigned).</li> <li>• All added users are deleted.</li> <li>• All passwords are deleted.</li> <li>• The camera is restarted.</li> </ul>

## 25.2 Power/error indicator LED and power modes

Indicator LED status	Explanation
The power/error indicator LED displays a pink light for 10 seconds.	Power is applied.
The power/error indicator LED displays a blue light.	Normal operation.

**25.3 Ethernet communication indicator LED**

<b>Indicator LED status</b>	<b>Explanation</b>
The Ethernet communication indicator LED displays a flashing green light.	The camera is connected to a network and the network activity is indicated.
The Ethernet communication indicator LED displays no light (i.e., it is switched off).	The camera is not connected to any network.

## 26.1 Camera housing, cables, and other items

### 26.1.1 Liquids

Use one of these liquids:

- Warm water
- A weak detergent solution

### 26.1.2 Equipment

A soft cloth

### 26.1.3 Procedure

Follow this procedure:

1. Soak the cloth in the liquid.
2. Twist the cloth to remove excess liquid.
3. Clean the part with the cloth.



#### CAUTION

Do not apply solvents or similar liquids to the camera, the cables, or other items. This can cause damage.

## 26.2 Infrared lens

### 26.2.1 Liquids

Use one of these liquids:

- A commercial lens cleaning liquid with more than 30% isopropyl alcohol.
- 96% ethyl alcohol (C<sub>2</sub>H<sub>5</sub>OH).

### 26.2.2 Equipment

Cotton wool

### 26.2.3 Procedure

Follow this procedure:

1. Soak the cotton wool in the liquid.
2. Twist the cotton wool to remove excess liquid.
3. Clean the lens one time only and discard the cotton wool.



#### WARNING

Make sure that you read all applicable MSDS (Material Safety Data Sheets) and warning labels on containers before you use a liquid: the liquids can be dangerous.



#### CAUTION

- Be careful when you clean the infrared lens. The lens has a delicate anti-reflective coating.
- Do not clean the infrared lens too vigorously. This can damage the anti-reflective coating.



# About FLIR Systems

FLIR Systems was established in 1978 to pioneer the development of high-performance infrared imaging systems, and is the world leader in the design, manufacture, and marketing of thermal imaging systems for a wide variety of commercial, industrial, and government applications. Today, FLIR Systems embraces five major companies with outstanding achievements in infrared technology since 1958—the Swedish AGEMA Infrared Systems (formerly AGA Infrared Systems), the three United States companies Inigo Systems, FSI, and Inframetrics, and the French company Cedicp.

Since 2007, FLIR Systems has acquired several companies with world-leading expertise in sensor technologies:

- Exttech Instruments (2007)
- Ifara Tecnologías (2008)
- Salvador Imaging (2009)
- OmniTech Partners (2009)
- Directed Perception (2009)
- Raymarine (2010)
- ICx Technologies (2010)
- TackTick Marine Digital Instruments (2011)
- Aerius Photonics (2011)
- Lorex Technology (2012)
- Traficon (2012)
- MARSS (2013)
- DigitalOptics micro-optics business (2013)
- DVTEL (2015)

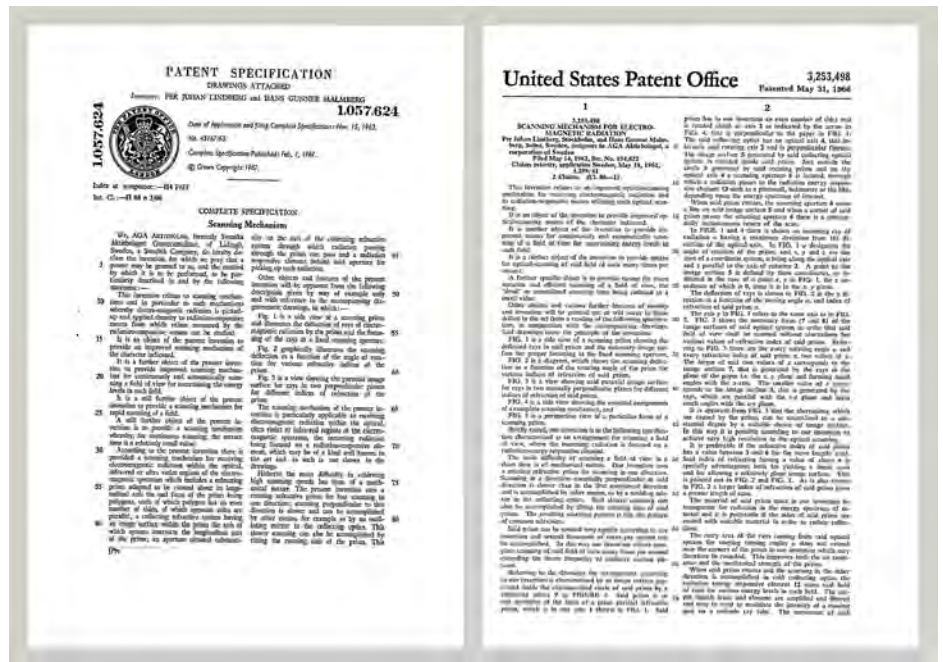

Figure 27.1 Patent documents from the early 1960s

FLIR Systems has three manufacturing plants in the United States (Portland, OR, Boston, MA, Santa Barbara, CA) and one in Sweden (Stockholm). Since 2007 there is also a manufacturing plant in Tallinn, Estonia. Direct sales offices in Belgium, Brazil, China, France, Germany, Great Britain, Hong Kong, Italy, Japan, Korea, Sweden, and the USA—together with a worldwide network of agents and distributors—support our international customer base.

FLIR Systems is at the forefront of innovation in the infrared camera industry. We anticipate market demand by constantly improving our existing cameras and developing new

ones. The company has set milestones in product design and development such as the introduction of the first battery-operated portable camera for industrial inspections, and the first uncooled infrared camera, to mention just two innovations.



**Figure 27.2** 1969: Thermovision Model 661. The camera weighed approximately 25 kg (55 lb.), the oscilloscope 20 kg (44 lb.), and the tripod 15 kg (33 lb.). The operator also needed a 220 VAC generator set, and a 10 L (2.6 US gallon) jar with liquid nitrogen. To the left of the oscilloscope the Polaroid attachment (6 kg/13 lb.) can be seen.



**Figure 27.3** 2015: FLIR One, an accessory to iPhone and Android mobile phones. Weight: 90 g (3.2 oz.).

FLIR Systems manufactures all vital mechanical and electronic components of the camera systems itself. From detector design and manufacturing, to lenses and system electronics, to final testing and calibration, all production steps are carried out and supervised by our own engineers. The in-depth expertise of these infrared specialists ensures the accuracy and reliability of all vital components that are assembled into your infrared camera.

### 27.1 More than just an infrared camera

At FLIR Systems we recognize that our job is to go beyond just producing the best infrared camera systems. We are committed to enabling all users of our infrared camera systems to work more productively by providing them with the most powerful camera–software combination. Especially tailored software for predictive maintenance, R & D, and process monitoring is developed in-house. Most software is available in a wide variety of languages.

We support all our infrared cameras with a wide variety of accessories to adapt your equipment to the most demanding infrared applications.

### 27.2 Sharing our knowledge

Although our cameras are designed to be very user-friendly, there is a lot more to thermography than just knowing how to handle a camera. Therefore, FLIR Systems has founded the Infrared Training Center (ITC), a separate business unit, that provides certified training courses. Attending one of the ITC courses will give you a truly hands-on learning experience.

The staff of the ITC are also there to provide you with any application support you may need in putting infrared theory into practice.

### 27.3 Supporting our customers

FLIR Systems operates a worldwide service network to keep your camera running at all times. If you discover a problem with your camera, local service centers have all the equipment and expertise to solve it within the shortest possible time. Therefore, there is

no need to send your camera to the other side of the world or to talk to someone who does not speak your language.

---

absorption (absorption factor)	The amount of radiation absorbed by an object relative to the received radiation. A number between 0 and 1.
atmosphere	The gases between the object being measured and the camera, normally air.
autoadjust	A function making a camera perform an internal image correction.
autopalette	The IR image is shown with an uneven spread of colors, displaying cold objects as well as hot ones at the same time.
blackbody	Totally non-reflective object. All its radiation is due to its own temperature.
blackbody radiator	An IR radiating equipment with blackbody properties used to calibrate IR cameras.
calculated atmospheric transmission	A transmission value computed from the temperature, the relative humidity of air and the distance to the object.
cavity radiator	A bottle shaped radiator with an absorbing inside, viewed through the bottleneck.
color temperature	The temperature for which the color of a blackbody matches a specific color.
conduction	The process that makes heat diffuse into a material.
continuous adjust	A function that adjusts the image. The function works all the time, continuously adjusting brightness and contrast according to the image content.
convection	Convection is a heat transfer mode where a fluid is brought into motion, either by gravity or another force, thereby transferring heat from one place to another.
dual isotherm	An isotherm with two color bands, instead of one.
emissivity (emissivity factor)	The amount of radiation coming from an object, compared to that of a blackbody. A number between 0 and 1.
emittance	Amount of energy emitted from an object per unit of time and area ( $W/m^2$ )
environment	Objects and gases that emit radiation towards the object being measured.
estimated atmospheric transmission	A transmission value, supplied by a user, replacing a calculated one
external optics	Extra lenses, filters, heat shields etc. that can be put between the camera and the object being measured.
filter	A material transparent only to some of the infrared wavelengths.
FOV	Field of view: The horizontal angle that can be viewed through an IR lens.
FPA	Focal plane array: A type of IR detector.
graybody	An object that emits a fixed fraction of the amount of energy of a blackbody for each wavelength.
IFOV	Instantaneous field of view: A measure of the geometrical resolution of an IR camera.

---

image correction (internal or external)	A way of compensating for sensitivity differences in various parts of live images and also of stabilizing the camera.
infrared	Non-visible radiation, having a wavelength from about 2–13 $\mu\text{m}$ .
IR	infrared
isotherm	A function highlighting those parts of an image that fall above, below or between one or more temperature intervals.
isothermal cavity	A bottle-shaped radiator with a uniform temperature viewed through the bottleneck.
Laser LocatIR	An electrically powered light source on the camera that emits laser radiation in a thin, concentrated beam to point at certain parts of the object in front of the camera.
laser pointer	An electrically powered light source on the camera that emits laser radiation in a thin, concentrated beam to point at certain parts of the object in front of the camera.
level	The center value of the temperature scale, usually expressed as a signal value.
manual adjust	A way to adjust the image by manually changing certain parameters.
NETD	Noise equivalent temperature difference. A measure of the image noise level of an IR camera.
noise	Undesired small disturbance in the infrared image
object parameters	A set of values describing the circumstances under which the measurement of an object was made, and the object itself (such as emissivity, reflected apparent temperature, distance etc.)
object signal	A non-calibrated value related to the amount of radiation received by the camera from the object.
palette	The set of colors used to display an IR image.
pixel	Stands for <i>picture element</i> . One single spot in an image.
radiance	Amount of energy emitted from an object per unit of time, area and angle ( $\text{W}/\text{m}^2/\text{sr}$ )
radiant power	Amount of energy emitted from an object per unit of time (W)
radiation	The process by which electromagnetic energy, is emitted by an object or a gas.
radiator	A piece of IR radiating equipment.
range	The current overall temperature measurement limitation of an IR camera. Cameras can have several ranges. Expressed as two blackbody temperatures that limit the current calibration.
reference temperature	A temperature which the ordinary measured values can be compared with.
reflection	The amount of radiation reflected by an object relative to the received radiation. A number between 0 and 1.
relative humidity	Relative humidity represents the ratio between the current water vapour mass in the air and the maximum it may contain in saturation conditions.
saturation color	The areas that contain temperatures outside the present level/span settings are colored with the saturation colors. The saturation colors contain an 'overflow' color and an 'underflow' color. There is also a third red saturation color that marks everything saturated by the detector indicating that the range should probably be changed.

---

span	The interval of the temperature scale, usually expressed as a signal value.
spectral (radiant) emittance	Amount of energy emitted from an object per unit of time, area and wavelength ( $W/m^2/\mu m$ )
temperature difference, or difference of temperature.	A value which is the result of a subtraction between two temperature values.
temperature range	The current overall temperature measurement limitation of an IR camera. Cameras can have several ranges. Expressed as two blackbody temperatures that limit the current calibration.
temperature scale	The way in which an IR image currently is displayed. Expressed as two temperature values limiting the colors.
thermogram	infrared image
transmission (or transmittance) factor	Gases and materials can be more or less transparent. Transmission is the amount of IR radiation passing through them. A number between 0 and 1.
transparent isotherm	An isotherm showing a linear spread of colors, instead of covering the highlighted parts of the image.
visual	Refers to the video mode of a IR camera, as opposed to the normal, thermographic mode. When a camera is in video mode it captures ordinary video images, while thermographic images are captured when the camera is in IR mode.

## 29.1 Introduction

An infrared camera measures and images the emitted infrared radiation from an object. The fact that radiation is a function of object surface temperature makes it possible for the camera to calculate and display this temperature.

However, the radiation measured by the camera does not only depend on the temperature of the object but is also a function of the emissivity. Radiation also originates from the surroundings and is reflected in the object. The radiation from the object and the reflected radiation will also be influenced by the absorption of the atmosphere.

To measure temperature accurately, it is therefore necessary to compensate for the effects of a number of different radiation sources. This is done on-line automatically by the camera. The following object parameters must, however, be supplied for the camera:

- The emissivity of the object
- The reflected apparent temperature
- The distance between the object and the camera
- The relative humidity
- Temperature of the atmosphere

## 29.2 Emissivity

The most important object parameter to set correctly is the emissivity which, in short, is a measure of how much radiation is emitted from the object, compared to that from a perfect blackbody of the same temperature.

Normally, object materials and surface treatments exhibit emissivity ranging from approximately 0.1 to 0.95. A highly polished (mirror) surface falls below 0.1, while an oxidized or painted surface has a higher emissivity. Oil-based paint, regardless of color in the visible spectrum, has an emissivity over 0.9 in the infrared. Human skin exhibits an emissivity 0.97 to 0.98.

Non-oxidized metals represent an extreme case of perfect opacity and high reflexivity, which does not vary greatly with wavelength. Consequently, the emissivity of metals is low – only increasing with temperature. For non-metals, emissivity tends to be high, and decreases with temperature.

### 29.2.1 Finding the emissivity of a sample

#### 29.2.1.1 Step 1: Determining reflected apparent temperature

Use one of the following two methods to determine reflected apparent temperature:

### 29.2.1.1.1 Method 1: Direct method

Follow this procedure:

1. Look for possible reflection sources, considering that the incident angle = reflection angle ( $a = b$ ).

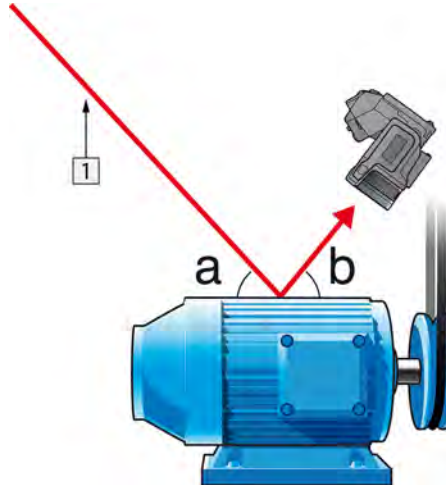

Figure 29.1 1 = Reflection source

2. If the reflection source is a spot source, modify the source by obstructing it using a piece of cardboard.

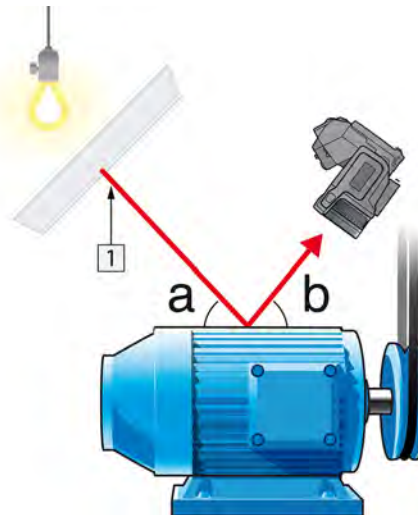

Figure 29.2 1 = Reflection source



3. Measure the radiation intensity (= apparent temperature) from the reflecting source using the following settings:

- Emissivity: 1.0
- $D_{obj}$ : 0

You can measure the radiation intensity using one of the following two methods:

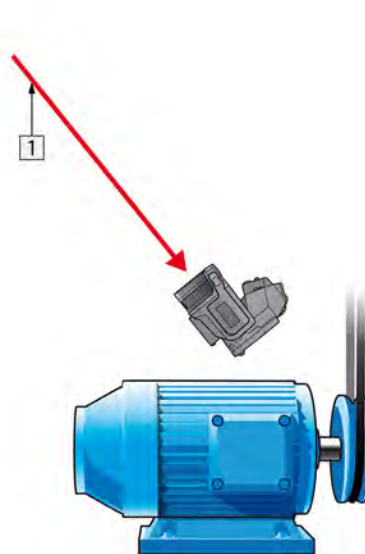

Figure 29.3 1 = Reflection source

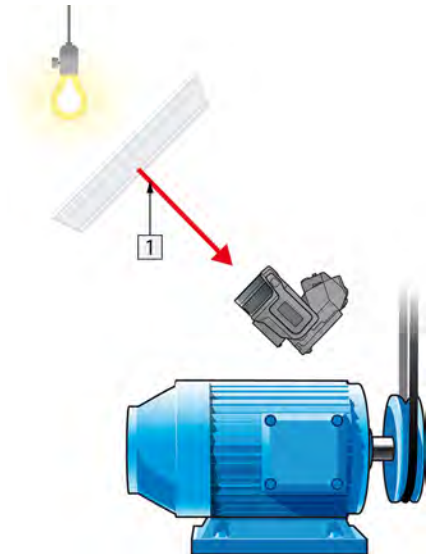

Figure 29.4 1 = Reflection source

Using a thermocouple to measure reflected apparent temperature is not recommended for two important reasons:

- A thermocouple does not measure radiation intensity
- A thermocouple requires a very good thermal contact to the surface, usually by gluing and covering the sensor by a thermal isolator.

#### 29.2.1.1.2 Method 2: Reflector method

Follow this procedure:

1. Crumble up a large piece of aluminum foil.
2. Uncrumble the aluminum foil and attach it to a piece of cardboard of the same size.
3. Put the piece of cardboard in front of the object you want to measure. Make sure that the side with aluminum foil points to the camera.
4. Set the emissivity to 1.0.

5. Measure the apparent temperature of the aluminum foil and write it down.

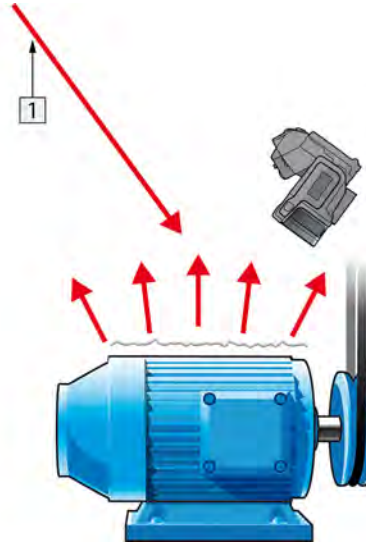

**Figure 29.5** Measuring the apparent temperature of the aluminum foil.

#### 29.2.1.2 Step 2: Determining the emissivity

Follow this procedure:

1. Select a place to put the sample.
2. Determine and set reflected apparent temperature according to the previous procedure.
3. Put a piece of electrical tape with known high emissivity on the sample.
4. Heat the sample at least 20 K above room temperature. Heating must be reasonably even.
5. Focus and auto-adjust the camera, and freeze the image.
6. Adjust *Level* and *Span* for best image brightness and contrast.
7. Set emissivity to that of the tape (usually 0.97).
8. Measure the temperature of the tape using one of the following measurement functions:
  - *Isotherm* (helps you to determine both the temperature and how evenly you have heated the sample)
  - *Spot* (simpler)
  - *Box Avg* (good for surfaces with varying emissivity).
9. Write down the temperature.
10. Move your measurement function to the sample surface.
11. Change the emissivity setting until you read the same temperature as your previous measurement.
12. Write down the emissivity.

#### Note

- Avoid forced convection
- Look for a thermally stable surrounding that will not generate spot reflections
- Use high quality tape that you know is not transparent, and has a high emissivity you are certain of
- This method assumes that the temperature of your tape and the sample surface are the same. If they are not, your emissivity measurement will be wrong.

### 29.3 Reflected apparent temperature

This parameter is used to compensate for the radiation reflected in the object. If the emissivity is low and the object temperature relatively far from that of the reflected it will be important to set and compensate for the reflected apparent temperature correctly.

#### 29.4 Distance

The distance is the distance between the object and the front lens of the camera. This parameter is used to compensate for the following two facts:

- That radiation from the target is absorbed by the atmosphere between the object and the camera.
- That radiation from the atmosphere itself is detected by the camera.

#### 29.5 Relative humidity

The camera can also compensate for the fact that the transmittance is also dependent on the relative humidity of the atmosphere. To do this set the relative humidity to the correct value. For short distances and normal humidity the relative humidity can normally be left at a default value of 50%.

#### 29.6 Other parameters

In addition, some cameras and analysis programs from FLIR Systems allow you to compensate for the following parameters:

- Atmospheric temperature – *i.e.* the temperature of the atmosphere between the camera and the target
- External optics temperature – *i.e.* the temperature of any external lenses or windows used in front of the camera
- External optics transmittance – *i.e.* the transmission of any external lenses or windows used in front of the camera

Before the year 1800, the existence of the infrared portion of the electromagnetic spectrum wasn't even suspected. The original significance of the infrared spectrum, or simply 'the infrared' as it is often called, as a form of heat radiation is perhaps less obvious today than it was at the time of its discovery by Herschel in 1800.



**Figure 30.1** Sir William Herschel (1738–1822)

The discovery was made accidentally during the search for a new optical material. Sir William Herschel – Royal Astronomer to King George III of England, and already famous for his discovery of the planet Uranus – was searching for an optical filter material to reduce the brightness of the sun's image in telescopes during solar observations. While testing different samples of colored glass which gave similar reductions in brightness he was intrigued to find that some of the samples passed very little of the sun's heat, while others passed so much heat that he risked eye damage after only a few seconds' observation.

Herschel was soon convinced of the necessity of setting up a systematic experiment, with the objective of finding a single material that would give the desired reduction in brightness as well as the maximum reduction in heat. He began the experiment by actually repeating Newton's prism experiment, but looking for the heating effect rather than the visual distribution of intensity in the spectrum. He first blackened the bulb of a sensitive mercury-in-glass thermometer with ink, and with this as his radiation detector he proceeded to test the heating effect of the various colors of the spectrum formed on the top of a table by passing sunlight through a glass prism. Other thermometers, placed outside the sun's rays, served as controls.

As the blackened thermometer was moved slowly along the colors of the spectrum, the temperature readings showed a steady increase from the violet end to the red end. This was not entirely unexpected, since the Italian researcher, Landriani, in a similar experiment in 1777 had observed much the same effect. It was Herschel, however, who was the first to recognize that there must be a point where the heating effect reaches a maximum, and that measurements confined to the visible portion of the spectrum failed to locate this point.



**Figure 30.2** Marsilio Landriani (1746–1815)

Moving the thermometer into the dark region beyond the red end of the spectrum, Herschel confirmed that the heating continued to increase. The maximum point, when he found it, lay well beyond the red end – in what is known today as the 'infrared wavelengths'.

When Herschel revealed his discovery, he referred to this new portion of the electromagnetic spectrum as the 'thermometrical spectrum'. The radiation itself he sometimes referred to as 'dark heat', or simply 'the invisible rays'. Ironically, and contrary to popular opinion, it wasn't Herschel who originated the term 'infrared'. The word only began to appear in print around 75 years later, and it is still unclear who should receive credit as the originator.

Herschel's use of glass in the prism of his original experiment led to some early controversies with his contemporaries about the actual existence of the infrared wavelengths. Different investigators, in attempting to confirm his work, used various types of glass indiscriminately, having different transparencies in the infrared. Through his later experiments, Herschel was aware of the limited transparency of glass to the newly-discovered thermal radiation, and he was forced to conclude that optics for the infrared would probably be doomed to the use of reflective elements exclusively (i.e. plane and curved mirrors). Fortunately, this proved to be true only until 1830, when the Italian investigator, Melloni, made his great discovery that naturally occurring rock salt (NaCl) – which was available in large enough natural crystals to be made into lenses and prisms – is remarkably transparent to the infrared. The result was that rock salt became the principal infrared optical material, and remained so for the next hundred years, until the art of synthetic crystal growing was mastered in the 1930's.



**Figure 30.3** Macedonio Melloni (1798–1854)

Thermometers, as radiation detectors, remained unchallenged until 1829, the year Nobili invented the thermocouple. (Herschel's own thermometer could be read to  $0.2\text{ }^{\circ}\text{C}$  ( $0.036\text{ }^{\circ}\text{F}$ ), and later models were able to be read to  $0.05\text{ }^{\circ}\text{C}$  ( $0.09\text{ }^{\circ}\text{F}$ )). Then a breakthrough occurred; Melloni connected a number of thermocouples in series to form the first thermopile. The new device was at least 40 times as sensitive as the best thermometer of the day for detecting heat radiation – capable of detecting the heat from a person standing three meters away.

The first so-called 'heat-picture' became possible in 1840, the result of work by Sir John Herschel, son of the discoverer of the infrared and a famous astronomer in his own right. Based upon the differential evaporation of a thin film of oil when exposed to a heat pattern focused upon it, the thermal image could be seen by reflected light where the interference effects of the oil film made the image visible to the eye. Sir John also managed to obtain a primitive record of the thermal image on paper, which he called a 'thermograph'.



**Figure 30.4** Samuel P. Langley (1834–1906)

The improvement of infrared-detector sensitivity progressed slowly. Another major breakthrough, made by Langley in 1880, was the invention of the bolometer. This consisted of a thin blackened strip of platinum connected in one arm of a Wheatstone bridge circuit upon which the infrared radiation was focused and to which a sensitive galvanometer responded. This instrument is said to have been able to detect the heat from a cow at a distance of 400 meters.

An English scientist, Sir James Dewar, first introduced the use of liquefied gases as cooling agents (such as liquid nitrogen with a temperature of  $-196\text{ }^{\circ}\text{C}$  ( $-320.8\text{ }^{\circ}\text{F}$ )) in low temperature research. In 1892 he invented a unique vacuum insulating container in which it is possible to store liquefied gases for entire days. The common 'thermos bottle', used for storing hot and cold drinks, is based upon his invention.

Between the years 1900 and 1920, the inventors of the world 'discovered' the infrared. Many patents were issued for devices to detect personnel, artillery, aircraft, ships – and even icebergs. The first operating systems, in the modern sense, began to be developed during the 1914–18 war, when both sides had research programs devoted to the military exploitation of the infrared. These programs included experimental systems for enemy intrusion/detection, remote temperature sensing, secure communications, and 'flying torpedo' guidance. An infrared search system tested during this period was able to detect an approaching airplane at a distance of 1.5 km (0.94 miles), or a person more than 300 meters (984 ft.) away.

The most sensitive systems up to this time were all based upon variations of the bolometer idea, but the period between the two wars saw the development of two revolutionary new infrared detectors: the image converter and the photon detector. At first, the image converter received the greatest attention by the military, because it enabled an observer for the first time in history to literally 'see in the dark'. However, the sensitivity of the image converter was limited to the near infrared wavelengths, and the most interesting military targets (i.e. enemy soldiers) had to be illuminated by infrared search beams. Since this involved the risk of giving away the observer's position to a similarly-equipped enemy observer, it is understandable that military interest in the image converter eventually faded.

The tactical military disadvantages of so-called 'active' (i.e. search beam-equipped) thermal imaging systems provided impetus following the 1939–45 war for extensive secret military infrared-research programs into the possibilities of developing 'passive' (no search beam) systems around the extremely sensitive photon detector. During this period, military secrecy regulations completely prevented disclosure of the status of infrared-imaging technology. This secrecy only began to be lifted in the middle of the 1950's, and from that time adequate thermal-imaging devices finally began to be available to civilian science and industry.

### 31.1 Introduction

The subjects of infrared radiation and the related technique of thermography are still new to many who will use an infrared camera. In this section the theory behind thermography will be given.

### 31.2 The electromagnetic spectrum

The electromagnetic spectrum is divided arbitrarily into a number of wavelength regions, called *bands*, distinguished by the methods used to produce and detect the radiation. There is no fundamental difference between radiation in the different bands of the electromagnetic spectrum. They are all governed by the same laws and the only differences are those due to differences in wavelength.

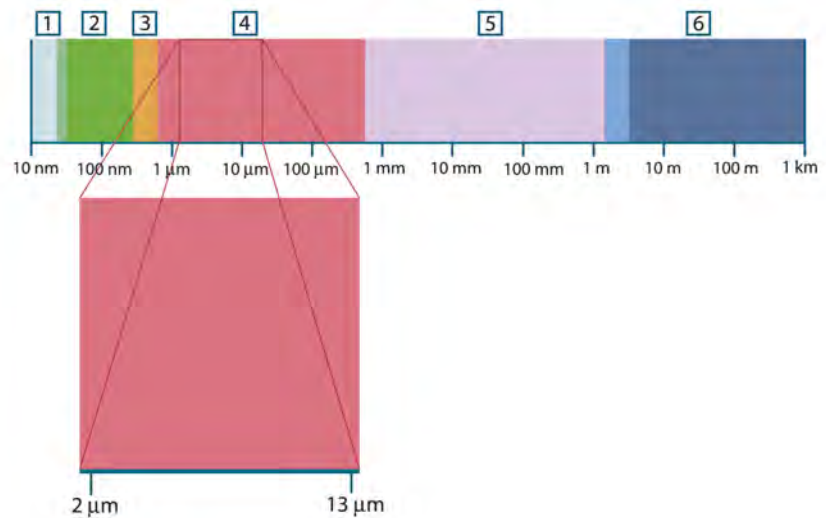

**Figure 31.1** The electromagnetic spectrum. 1: X-ray; 2: UV; 3: Visible; 4: IR; 5: Microwaves; 6: Radiowaves.

Thermography makes use of the infrared spectral band. At the short-wavelength end the boundary lies at the limit of visual perception, in the deep red. At the long-wavelength end it merges with the microwave radio wavelengths, in the millimeter range.

The infrared band is often further subdivided into four smaller bands, the boundaries of which are also arbitrarily chosen. They include: the *near infrared* (0.75–3 μm), the *middle infrared* (3–6 μm), the *far infrared* (6–15 μm) and the *extreme infrared* (15–100 μm). Although the wavelengths are given in μm (micrometers), other units are often still used to measure wavelength in this spectral region, e.g. nanometer (nm) and Ångström (Å).

The relationships between the different wavelength measurements is:

$$10\,000\ \text{Å} = 1\,000\ \text{nm} = 1\ \mu = 1\ \mu\text{m}.$$

### 31.3 Blackbody radiation

A blackbody is defined as an object which absorbs all radiation that impinges on it at any wavelength. The apparent misnomer *black* relating to an object emitting radiation is explained by Kirchhoff's Law (after *Gustav Robert Kirchhoff*, 1824–1887), which states that a body capable of absorbing all radiation at any wavelength is equally capable in the emission of radiation.



**Figure 31.2** Gustav Robert Kirchhoff (1824–1887)

The construction of a blackbody source is, in principle, very simple. The radiation characteristics of an aperture in an isotherm cavity made of an opaque absorbing material represents almost exactly the properties of a blackbody. A practical application of the principle to the construction of a perfect absorber of radiation consists of a box that is light tight except for an aperture in one of the sides. Any radiation which then enters the hole is scattered and absorbed by repeated reflections so only an infinitesimal fraction can possibly escape. The blackness which is obtained at the aperture is nearly equal to a blackbody and almost perfect for all wavelengths.

By providing such an isothermal cavity with a suitable heater it becomes what is termed a *cavity radiator*. An isothermal cavity heated to a uniform temperature generates blackbody radiation, the characteristics of which are determined solely by the temperature of the cavity. Such cavity radiators are commonly used as sources of radiation in temperature reference standards in the laboratory for calibrating thermographic instruments, such as a FLIR Systems camera for example.

If the temperature of blackbody radiation increases to more than 525°C (977°F), the source begins to be visible so that it appears to the eye no longer black. This is the incipient red heat temperature of the radiator, which then becomes orange or yellow as the temperature increases further. In fact, the definition of the so-called *color temperature* of an object is the temperature to which a blackbody would have to be heated to have the same appearance.

Now consider three expressions that describe the radiation emitted from a blackbody.

### 31.3.1 Planck's law



**Figure 31.3** Max Planck (1858–1947)

*Max Planck* (1858–1947) was able to describe the spectral distribution of the radiation from a blackbody by means of the following formula:

$$W_{\lambda b} = \frac{2\pi hc^2}{\lambda^5 \left( e^{\frac{hc}{\lambda kT}} - 1 \right)} \times 10^{-6} [\text{Watt} / \text{m}^2, \mu\text{m}]$$



where:

$W_{\lambda b}$	Blackbody spectral radiant emittance at wavelength $\lambda$ .
$c$	Velocity of light = $3 \times 10^8$ m/s
$h$	Planck's constant = $6.6 \times 10^{-34}$ Joule sec.
$k$	Boltzmann's constant = $1.4 \times 10^{-23}$ Joule/K.
$T$	Absolute temperature (K) of a blackbody.
$\lambda$	Wavelength ( $\mu\text{m}$ ).

**Note** The factor  $10^{-6}$  is used since spectral emittance in the curves is expressed in  $\text{Watt/m}^2, \mu\text{m}$ .

Planck's formula, when plotted graphically for various temperatures, produces a family of curves. Following any particular Planck curve, the spectral emittance is zero at  $\lambda = 0$ , then increases rapidly to a maximum at a wavelength  $\lambda_{\text{max}}$  and after passing it approaches zero again at very long wavelengths. The higher the temperature, the shorter the wavelength at which maximum occurs.

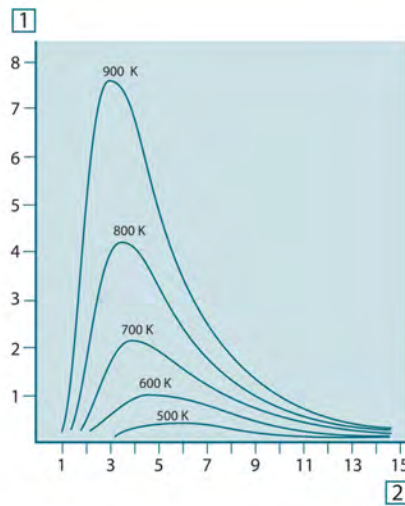

**Figure 31.4** Blackbody spectral radiant emittance according to Planck's law, plotted for various absolute temperatures. 1: Spectral radiant emittance ( $\text{W/cm}^2 \times 10^3(\mu\text{m})$ ); 2: Wavelength ( $\mu\text{m}$ )

### 31.3.2 Wien's displacement law

By differentiating Planck's formula with respect to  $\lambda$ , and finding the maximum, we have:

$$\lambda_{\text{max}} = \frac{2898}{T} [\mu\text{m}]$$

This is Wien's formula (after *Wilhelm Wien*, 1864–1928), which expresses mathematically the common observation that colors vary from red to orange or yellow as the temperature of a thermal radiator increases. The wavelength of the color is the same as the wavelength calculated for  $\lambda_{\text{max}}$ . A good approximation of the value of  $\lambda_{\text{max}}$  for a given blackbody temperature is obtained by applying the rule-of-thumb  $3\,000/T \mu\text{m}$ . Thus, a very hot star such as Sirius (11 000 K), emitting bluish-white light, radiates with the peak of spectral radiant emittance occurring within the invisible ultraviolet spectrum, at wavelength  $0.27 \mu\text{m}$ .



**Figure 31.5** Wilhelm Wien (1864–1928)

The sun (approx. 6 000 K) emits yellow light, peaking at about 0.5  $\mu\text{m}$  in the middle of the visible light spectrum.

At room temperature (300 K) the peak of radiant emittance lies at 9.7  $\mu\text{m}$ , in the far infrared, while at the temperature of liquid nitrogen (77 K) the maximum of the almost insignificant amount of radiant emittance occurs at 38  $\mu\text{m}$ , in the extreme infrared wavelengths.

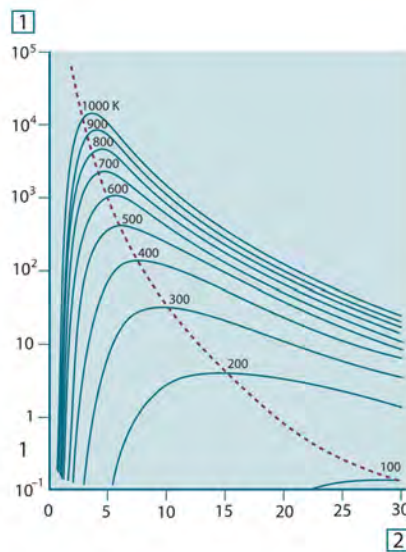

**Figure 31.6** Planckian curves plotted on semi-log scales from 100 K to 1000 K. The dotted line represents the locus of maximum radiant emittance at each temperature as described by Wien's displacement law. 1: Spectral radiant emittance ( $\text{W}/\text{cm}^2 (\mu\text{m})$ ); 2: Wavelength ( $\mu\text{m}$ ).

### 31.3.3 Stefan-Boltzmann's law

By integrating Planck's formula from  $\lambda = 0$  to  $\lambda = \infty$ , we obtain the total radiant emittance ( $W_b$ ) of a blackbody:

$$W_b = \sigma T^4 \quad [\text{Watt}/\text{m}^2]$$

This is the Stefan-Boltzmann formula (after *Josef Stefan*, 1835–1893, and *Ludwig Boltzmann*, 1844–1906), which states that the total emissive power of a blackbody is proportional to the fourth power of its absolute temperature. Graphically,  $W_b$  represents the area below the Planck curve for a particular temperature. It can be shown that the radiant emittance in the interval  $\lambda = 0$  to  $\lambda_{\text{max}}$  is only 25% of the total, which represents about the amount of the sun's radiation which lies inside the visible light spectrum.



**Figure 31.7** Josef Stefan (1835–1893), and Ludwig Boltzmann (1844–1906)

Using the Stefan-Boltzmann formula to calculate the power radiated by the human body, at a temperature of 300 K and an external surface area of approx. 2 m<sup>2</sup>, we obtain 1 kW. This power loss could not be sustained if it were not for the compensating absorption of radiation from surrounding surfaces, at room temperatures which do not vary too drastically from the temperature of the body – or, of course, the addition of clothing.

### 31.3.4 Non-blackbody emitters

So far, only blackbody radiators and blackbody radiation have been discussed. However, real objects almost never comply with these laws over an extended wavelength region – although they may approach the blackbody behavior in certain spectral intervals. For example, a certain type of white paint may appear perfectly *white* in the visible light spectrum, but becomes distinctly *gray* at about 2 μm, and beyond 3 μm it is almost *black*.

There are three processes which can occur that prevent a real object from acting like a blackbody: a fraction of the incident radiation  $\alpha$  may be absorbed, a fraction  $\rho$  may be reflected, and a fraction  $\tau$  may be transmitted. Since all of these factors are more or less wavelength dependent, the subscript  $\lambda$  is used to imply the spectral dependence of their definitions. Thus:

- The spectral absorptance  $\alpha_\lambda$  = the ratio of the spectral radiant power absorbed by an object to that incident upon it.
- The spectral reflectance  $\rho_\lambda$  = the ratio of the spectral radiant power reflected by an object to that incident upon it.
- The spectral transmittance  $\tau_\lambda$  = the ratio of the spectral radiant power transmitted through an object to that incident upon it.

The sum of these three factors must always add up to the whole at any wavelength, so we have the relation:

$$\alpha_\lambda + \rho_\lambda + \tau_\lambda = 1$$

For opaque materials  $\tau_\lambda = 0$  and the relation simplifies to:

$$\alpha_\lambda + \rho_\lambda = 1$$

Another factor, called the emissivity, is required to describe the fraction  $\varepsilon$  of the radiant emittance of a blackbody produced by an object at a specific temperature. Thus, we have the definition:

The spectral emissivity  $\varepsilon_\lambda$  = the ratio of the spectral radiant power from an object to that from a blackbody at the same temperature and wavelength.

Expressed mathematically, this can be written as the ratio of the spectral emittance of the object to that of a blackbody as follows:

$$\varepsilon_\lambda = \frac{W_{\lambda o}}{W_{\lambda b}}$$

Generally speaking, there are three types of radiation source, distinguished by the ways in which the spectral emittance of each varies with wavelength.

- A blackbody, for which  $\varepsilon_\lambda = \varepsilon = 1$
- A graybody, for which  $\varepsilon_\lambda = \varepsilon = \text{constant less than 1}$

- A selective radiator, for which  $\varepsilon$  varies with wavelength

According to Kirchhoff's law, for any material the spectral emissivity and spectral absorptance of a body are equal at any specified temperature and wavelength. That is:

$$\varepsilon_\lambda = \alpha_\lambda$$

From this we obtain, for an opaque material (since  $\alpha_\lambda + \rho_\lambda = 1$ ):

$$\varepsilon_\lambda + \rho_\lambda = 1$$

For highly polished materials  $\varepsilon_\lambda$  approaches zero, so that for a perfectly reflecting material (*i.e.* a perfect mirror) we have:

$$\rho_\lambda = 1$$

For a graybody radiator, the Stefan-Boltzmann formula becomes:

$$W = \varepsilon \sigma T^4 \text{ [Watt/m}^2\text{]}$$

This states that the total emissive power of a graybody is the same as a blackbody at the same temperature reduced in proportion to the value of  $\varepsilon$  from the graybody.

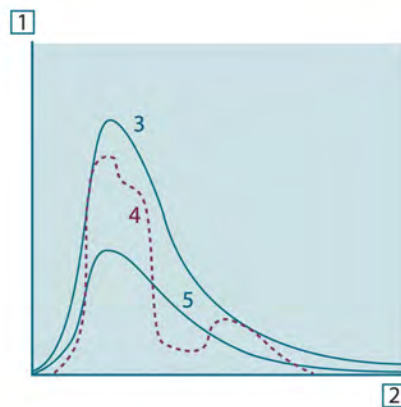

**Figure 31.8** Spectral radiant emittance of three types of radiators. 1: Spectral radiant emittance; 2: Wavelength; 3: Blackbody; 4: Selective radiator; 5: Graybody.

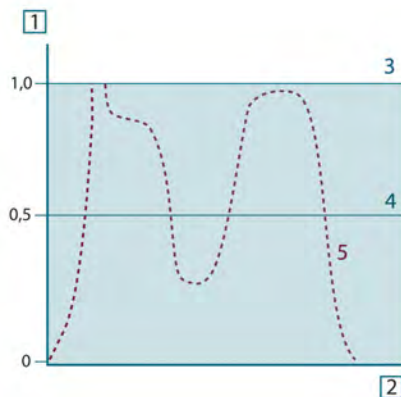

**Figure 31.9** Spectral emissivity of three types of radiators. 1: Spectral emissivity; 2: Wavelength; 3: Blackbody; 4: Graybody; 5: Selective radiator.

### 31.4 Infrared semi-transparent materials

Consider now a non-metallic, semi-transparent body – let us say, in the form of a thick flat plate of plastic material. When the plate is heated, radiation generated within its volume must work its way toward the surfaces through the material in which it is partially absorbed. Moreover, when it arrives at the surface, some of it is reflected back into the interior. The back-reflected radiation is again partially absorbed, but some of it arrives at the other surface, through which most of it escapes; part of it is reflected back again. Although the progressive reflections become weaker and weaker they must all be added up when the total emittance of the plate is sought. When the resulting geometrical series is summed, the effective emissivity of a semi-transparent plate is obtained as:

$$\epsilon_{\lambda} = \frac{(1 - \rho_{\lambda})(1 - \tau_{\lambda})}{1 - \rho_{\lambda}\tau_{\lambda}}$$

When the plate becomes opaque this formula is reduced to the single formula:

$$\epsilon_{\lambda} = 1 - \rho_{\lambda}$$

This last relation is a particularly convenient one, because it is often easier to measure reflectance than to measure emissivity directly.

As already mentioned, when viewing an object, the camera receives radiation not only from the object itself. It also collects radiation from the surroundings reflected via the object surface. Both these radiation contributions become attenuated to some extent by the atmosphere in the measurement path. To this comes a third radiation contribution from the atmosphere itself.

This description of the measurement situation, as illustrated in the figure below, is so far a fairly true description of the real conditions. What has been neglected could for instance be sun light scattering in the atmosphere or stray radiation from intense radiation sources outside the field of view. Such disturbances are difficult to quantify, however, in most cases they are fortunately small enough to be neglected. In case they are not negligible, the measurement configuration is likely to be such that the risk for disturbance is obvious, at least to a trained operator. It is then his responsibility to modify the measurement situation to avoid the disturbance e.g. by changing the viewing direction, shielding off intense radiation sources etc.

Accepting the description above, we can use the figure below to derive a formula for the calculation of the object temperature from the calibrated camera output.

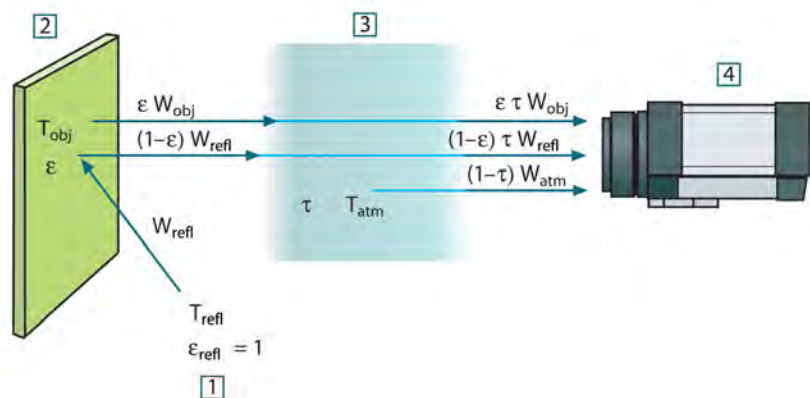

**Figure 32.1** A schematic representation of the general thermographic measurement situation. 1: Surroundings; 2: Object; 3: Atmosphere; 4: Camera

Assume that the received radiation power  $W$  from a blackbody source of temperature  $T_{\text{source}}$  on short distance generates a camera output signal  $U_{\text{source}}$  that is proportional to the power input (power linear camera). We can then write (Equation 1):

$$U_{\text{source}} = CW(T_{\text{source}})$$

or, with simplified notation:

$$U_{\text{source}} = CW_{\text{source}}$$

where  $C$  is a constant.

Should the source be a graybody with emittance  $\epsilon$ , the received radiation would consequently be  $\epsilon W_{\text{source}}$ .

We are now ready to write the three collected radiation power terms:

1. *Emission from the object* =  $\epsilon \tau W_{\text{obj}}$ , where  $\epsilon$  is the emittance of the object and  $\tau$  is the transmittance of the atmosphere. The object temperature is  $T_{\text{obj}}$ .

2. *Reflected emission from ambient sources* =  $(1 - \varepsilon)\tau W_{\text{refl}}$ , where  $(1 - \varepsilon)$  is the reflectance of the object. The ambient sources have the temperature  $T_{\text{refl}}$ .  
 It has here been assumed that the temperature  $T_{\text{refl}}$  is the same for all emitting surfaces within the halfsphere seen from a point on the object surface. This is of course sometimes a simplification of the true situation. It is, however, a necessary simplification in order to derive a workable formula, and  $T_{\text{refl}}$  can – at least theoretically – be given a value that represents an efficient temperature of a complex surrounding.

Note also that we have assumed that the emittance for the surroundings = 1. This is correct in accordance with Kirchhoff’s law: All radiation impinging on the surrounding surfaces will eventually be absorbed by the same surfaces. Thus the emittance = 1. (Note though that the latest discussion requires the complete sphere around the object to be considered.)

3. *Emission from the atmosphere* =  $(1 - \tau)W_{\text{atm}}$ , where  $(1 - \tau)$  is the emittance of the atmosphere. The temperature of the atmosphere is  $T_{\text{atm}}$ .

The total received radiation power can now be written (Equation 2):

$$W_{\text{tot}} = \varepsilon\tau W_{\text{obj}} + (1 - \varepsilon)\tau W_{\text{refl}} + (1 - \tau)W_{\text{atm}}$$

We multiply each term by the constant C of Equation 1 and replace the CW products by the corresponding U according to the same equation, and get (Equation 3):

$$U_{\text{tot}} = \varepsilon\tau U_{\text{obj}} + (1 - \varepsilon)\tau U_{\text{refl}} + (1 - \tau)U_{\text{atm}}$$

Solve Equation 3 for  $U_{\text{obj}}$  (Equation 4):

$$U_{\text{obj}} = \frac{1}{\varepsilon\tau} U_{\text{tot}} - \frac{1 - \varepsilon}{\varepsilon} U_{\text{refl}} - \frac{1 - \tau}{\varepsilon\tau} U_{\text{atm}}$$

This is the general measurement formula used in all the FLIR Systems thermographic equipment. The voltagages of the formula are:

**Table 32.1** Voltages

$U_{\text{obj}}$	Calculated camera output voltage for a blackbody of temperature $T_{\text{obj}}$ i.e. a voltage that can be directly converted into true requested object temperature.
$U_{\text{tot}}$	Measured camera output voltage for the actual case.
$U_{\text{refl}}$	Theoretical camera output voltage for a blackbody of temperature $T_{\text{refl}}$ according to the calibration.
$U_{\text{atm}}$	Theoretical camera output voltage for a blackbody of temperature $T_{\text{atm}}$ according to the calibration.

The operator has to supply a number of parameter values for the calculation:

- the object emittance  $\varepsilon$ ,
- the relative humidity,
- $T_{\text{atm}}$
- object distance ( $D_{\text{obj}}$ )
- the (effective) temperature of the object surroundings, or the reflected ambient temperature  $T_{\text{refl}}$ , and
- the temperature of the atmosphere  $T_{\text{atm}}$

This task could sometimes be a heavy burden for the operator since there are normally no easy ways to find accurate values of emittance and atmospheric transmittance for the actual case. The two temperatures are normally less of a problem provided the surroundings do not contain large and intense radiation sources.

A natural question in this connection is: How important is it to know the right values of these parameters? It could though be of interest to get a feeling for this problem already here by looking into some different measurement cases and compare the relative

magnitudes of the three radiation terms. This will give indications about when it is important to use correct values of which parameters.

The figures below illustrates the relative magnitudes of the three radiation contributions for three different object temperatures, two emittances, and two spectral ranges: SW and LW. Remaining parameters have the following fixed values:

- $\tau = 0.88$
- $T_{\text{refl}} = +20^{\circ}\text{C}$  ( $+68^{\circ}\text{F}$ )
- $T_{\text{atm}} = +20^{\circ}\text{C}$  ( $+68^{\circ}\text{F}$ )

It is obvious that measurement of low object temperatures are more critical than measuring high temperatures since the 'disturbing' radiation sources are relatively much stronger in the first case. Should also the object emittance be low, the situation would be still more difficult.

We have finally to answer a question about the importance of being allowed to use the calibration curve above the highest calibration point, what we call extrapolation. Imagine that we in a certain case measure  $U_{\text{tot}} = 4.5$  volts. The highest calibration point for the camera was in the order of 4.1 volts, a value unknown to the operator. Thus, even if the object happened to be a blackbody, i.e.  $U_{\text{obj}} = U_{\text{tot}}$ , we are actually performing extrapolation of the calibration curve when converting 4.5 volts into temperature.

Let us now assume that the object is not black, it has an emittance of 0.75, and the transmittance is 0.92. We also assume that the two second terms of Equation 4 amount to 0.5 volts together. Computation of  $U_{\text{obj}}$  by means of Equation 4 then results in  $U_{\text{obj}} = 4.5 / 0.75 / 0.92 - 0.5 = 6.0$ . This is a rather extreme extrapolation, particularly when considering that the video amplifier might limit the output to 5 volts! Note, though, that the application of the calibration curve is a theoretical procedure where no electronic or other limitations exist. We trust that if there had been no signal limitations in the camera, and if it had been calibrated far beyond 5 volts, the resulting curve would have been very much the same as our real curve extrapolated beyond 4.1 volts, provided the calibration algorithm is based on radiation physics, like the FLIR Systems algorithm. Of course there must be a limit to such extrapolations.

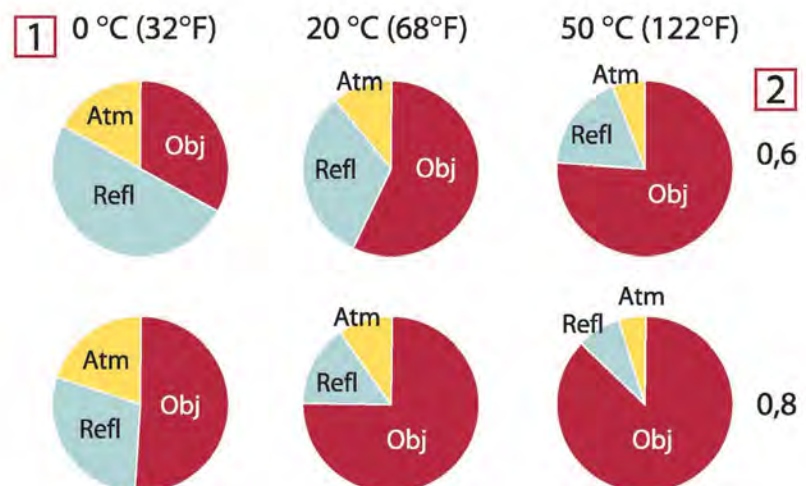

**Figure 32.2** Relative magnitudes of radiation sources under varying measurement conditions (SW camera). 1: Object temperature; 2: Emittance; Obj: Object radiation; Refl: Reflected radiation; Atm: atmosphere radiation. Fixed parameters:  $\tau = 0.88$ ;  $T_{\text{refl}} = 20^{\circ}\text{C}$  ( $+68^{\circ}\text{F}$ );  $T_{\text{atm}} = 20^{\circ}\text{C}$  ( $+68^{\circ}\text{F}$ ).



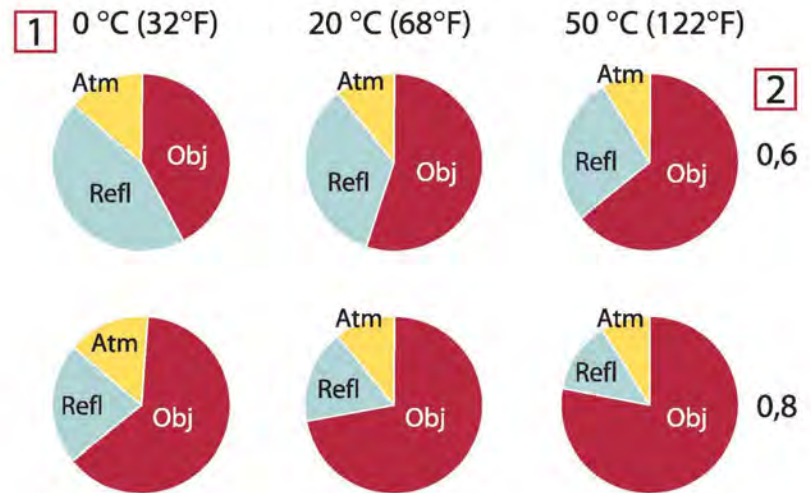

**Figure 32.3** Relative magnitudes of radiation sources under varying measurement conditions (LW camera). 1: Object temperature; 2: Emittance; Obj: Object radiation; Refl: Reflected radiation; Atm: atmosphere radiation. Fixed parameters:  $\tau = 0.88$ ;  $T_{\text{refl}} = 20^{\circ}\text{C}$  (+68°F);  $T_{\text{atm}} = 20^{\circ}\text{C}$  (+68°F).

This section presents a compilation of emissivity data from the infrared literature and measurements made by FLIR Systems.

### 33.1 References

1. Mikaél A. Bramson: *Infrared Radiation, A Handbook for Applications*, Plenum press, N.Y.
2. William L. Wolfe, George J. Zissis: *The Infrared Handbook*, Office of Naval Research, Department of Navy, Washington, D.C.
3. Madding, R. P.: *Thermographic Instruments and systems*. Madison, Wisconsin: University of Wisconsin – Extension, Department of Engineering and Applied Science.
4. William L. Wolfe: *Handbook of Military Infrared Technology*, Office of Naval Research, Department of Navy, Washington, D.C.
5. Jones, Smith, Probert: *External thermography of buildings...*, Proc. of the Society of Photo-Optical Instrumentation Engineers, vol.110, Industrial and Civil Applications of Infrared Technology, June 1977 London.
6. Paljak, Pettersson: *Thermography of Buildings*, Swedish Building Research Institute, Stockholm 1972.
7. Vlcek, J: *Determination of emissivity with imaging radiometers and some emissivities at  $\lambda = 5 \mu\text{m}$* . Photogrammetric Engineering and Remote Sensing.
8. Kern: *Evaluation of infrared emission of clouds and ground as measured by weather satellites*, Defence Documentation Center, AD 617 417.
9. Öhman, Claes: *Emittansmätningar med AGEMA E-Box*. Teknisk rapport, AGEMA 1999. (Emittance measurements using AGEMA E-Box. Technical report, AGEMA 1999.)
10. Mattei, S., Tang-Kwor, E: *Emissivity measurements for Nextel Velvet coating 811-21 between  $-36^{\circ}\text{C}$  AND  $82^{\circ}\text{C}$* .
11. Lohrengel & Todtenhaupt (1996)
12. ITC Technical publication 32.
13. ITC Technical publication 29.
14. Schuster, Norbert and Kolobrodov, Valentin G. *Infrarotthermographie*. Berlin: Wiley-VCH, 2000.

**Note** The emissivity values in the table below are recorded using a shortwave (SW) camera. The values should be regarded as recommendations only and used with caution.

### 33.2 Tables

**Table 33.1** T: Total spectrum; SW: 2–5  $\mu\text{m}$ ; LW: 8–14  $\mu\text{m}$ , LLW: 6.5–20  $\mu\text{m}$ ; 1: Material; 2: Specification; 3: Temperature in  $^{\circ}\text{C}$ ; 4: Spectrum; 5: Emissivity; 6: Reference

1	2	3	4	5	6
3M type 35	Vinyl electrical tape (several colors)	< 80	LW	$\approx 0.96$	13
3M type 88	Black vinyl electrical tape	< 105	LW	$\approx 0.96$	13
3M type 88	Black vinyl electrical tape	< 105	MW	< 0.96	13
3M type Super 33+	Black vinyl electrical tape	< 80	LW	$\approx 0.96$	13
Aluminum	anodized sheet	100	T	0.55	2
Aluminum	anodized, black, dull	70	SW	0.67	9
Aluminum	anodized, black, dull	70	LW	0.95	9
Aluminum	anodized, light gray, dull	70	SW	0.61	9

## Emissivity tables

**Table 33.1** T: Total spectrum; SW: 2–5  $\mu\text{m}$ ; LW: 8–14  $\mu\text{m}$ , LLW: 6.5–20  $\mu\text{m}$ ; 1: Material; 2: Specification; 3: Temperature in  $^{\circ}\text{C}$ ; 4: Spectrum; 5: Emissivity; 6: Reference (continued)

1	2	3	4	5	6
Aluminum	anodized, light gray, dull	70	LW	0.97	9
Aluminum	as received, plate	100	T	0.09	4
Aluminum	as received, sheet	100	T	0.09	2
Aluminum	cast, blast cleaned	70	SW	0.47	9
Aluminum	cast, blast cleaned	70	LW	0.46	9
Aluminum	dipped in $\text{HNO}_3$ , plate	100	T	0.05	4
Aluminum	foil	27	10 $\mu\text{m}$	0.04	3
Aluminum	foil	27	3 $\mu\text{m}$	0.09	3
Aluminum	oxidized, strongly	50–500	T	0.2–0.3	1
Aluminum	polished	50–100	T	0.04–0.06	1
Aluminum	polished plate	100	T	0.05	4
Aluminum	polished, sheet	100	T	0.05	2
Aluminum	rough surface	20–50	T	0.06–0.07	1
Aluminum	roughened	27	10 $\mu\text{m}$	0.18	3
Aluminum	roughened	27	3 $\mu\text{m}$	0.28	3
Aluminum	sheet, 4 samples differently scratched	70	SW	0.05–0.08	9
Aluminum	sheet, 4 samples differently scratched	70	LW	0.03–0.06	9
Aluminum	vacuum deposited	20	T	0.04	2
Aluminum	weathered, heavily	17	SW	0.83–0.94	5
Aluminum bronze		20	T	0.60	1
Aluminum hydroxide	powder		T	0.28	1
Aluminum oxide	activated, powder		T	0.46	1
Aluminum oxide	pure, powder (alumina)		T	0.16	1
Asbestos	board	20	T	0.96	1
Asbestos	fabric		T	0.78	1
Asbestos	floor tile	35	SW	0.94	7
Asbestos	paper	40–400	T	0.93–0.95	1
Asbestos	powder		T	0.40–0.60	1
Asbestos	slate	20	T	0.96	1
Asphalt paving		4	LLW	0.967	8
Brass	dull, tarnished	20–350	T	0.22	1
Brass	oxidized	100	T	0.61	2
Brass	oxidized	70	SW	0.04–0.09	9
Brass	oxidized	70	LW	0.03–0.07	9
Brass	oxidized at 600 $^{\circ}\text{C}$	200–600	T	0.59–0.61	1

**Table 33.1** T: Total spectrum; SW: 2–5 µm; LW: 8–14 µm, LLW: 6.5–20 µm; 1: Material; 2: Specification; 3: Temperature in °C; 4: Spectrum; 5: Emissivity; 6: Reference (continued)

1	2	3	4	5	6
Brass	polished	200	T	0.03	1
Brass	polished, highly	100	T	0.03	2
Brass	rubbed with 80-grit emery	20	T	0.20	2
Brass	sheet, rolled	20	T	0.06	1
Brass	sheet, worked with emery	20	T	0.2	1
Brick	alumina	17	SW	0.68	5
Brick	common	17	SW	0.86–0.81	5
Brick	Dinas silica, glazed, rough	1100	T	0.85	1
Brick	Dinas silica, refractory	1000	T	0.66	1
Brick	Dinas silica, unglazed, rough	1000	T	0.80	1
Brick	firebrick	17	SW	0.68	5
Brick	fireclay	1000	T	0.75	1
Brick	fireclay	1200	T	0.59	1
Brick	fireclay	20	T	0.85	1
Brick	masonry	35	SW	0.94	7
Brick	masonry, plastered	20	T	0.94	1
Brick	red, common	20	T	0.93	2
Brick	red, rough	20	T	0.88–0.93	1
Brick	refractory, corundum	1000	T	0.46	1
Brick	refractory, magnesite	1000–1300	T	0.38	1
Brick	refractory, strongly radiating	500–1000	T	0.8–0.9	1
Brick	refractory, weakly radiating	500–1000	T	0.65–0.75	1
Brick	silica, 95% SiO <sub>2</sub>	1230	T	0.66	1
Brick	sillimanite, 33% SiO <sub>2</sub> , 64% Al <sub>2</sub> O <sub>3</sub>	1500	T	0.29	1
Brick	waterproof	17	SW	0.87	5
Bronze	phosphor bronze	70	SW	0.08	9
Bronze	phosphor bronze	70	LW	0.06	9
Bronze	polished	50	T	0.1	1
Bronze	porous, rough	50–150	T	0.55	1
Bronze	powder		T	0.76–0.80	1
Carbon	candle soot	20	T	0.95	2
Carbon	charcoal powder		T	0.96	1
Carbon	graphite powder		T	0.97	1
Carbon	graphite, filed surface	20	T	0.98	2
Carbon	lampblack	20–400	T	0.95–0.97	1

**Table 33.1** T: Total spectrum; SW: 2–5 µm; LW: 8–14 µm, LLW: 6.5–20 µm; 1: Material; 2: Specification; 3: Temperature in °C; 4: Spectrum; 5: Emissivity; 6: Reference (continued)

1	2	3	4	5	6
Chipboard	untreated	20	SW	0.90	6
Chromium	polished	50	T	0.10	1
Chromium	polished	500–1000	T	0.28–0.38	1
Clay	fired	70	T	0.91	1
Cloth	black	20	T	0.98	1
Concrete		20	T	0.92	2
Concrete	dry	36	SW	0.95	7
Concrete	rough	17	SW	0.97	5
Concrete	walkway	5	LLW	0.974	8
Copper	commercial, burnished	20	T	0.07	1
Copper	electrolytic, carefully polished	80	T	0.018	1
Copper	electrolytic, polished	–34	T	0.006	4
Copper	molten	1100–1300	T	0.13–0.15	1
Copper	oxidized	50	T	0.6–0.7	1
Copper	oxidized to blackness		T	0.88	1
Copper	oxidized, black	27	T	0.78	4
Copper	oxidized, heavily	20	T	0.78	2
Copper	polished	50–100	T	0.02	1
Copper	polished	100	T	0.03	2
Copper	polished, commercial	27	T	0.03	4
Copper	polished, mechanical	22	T	0.015	4
Copper	pure, carefully prepared surface	22	T	0.008	4
Copper	scraped	27	T	0.07	4
Copper dioxide	powder		T	0.84	1
Copper oxide	red, powder		T	0.70	1
Ebonite			T	0.89	1
Emery	coarse	80	T	0.85	1
Enamel		20	T	0.9	1
Enamel	lacquer	20	T	0.85–0.95	1
Fiber board	hard, untreated	20	SW	0.85	6
Fiber board	masonite	70	SW	0.75	9
Fiber board	masonite	70	LW	0.88	9
Fiber board	particle board	70	SW	0.77	9
Fiber board	particle board	70	LW	0.89	9
Fiber board	porous, untreated	20	SW	0.85	6
Glass pane (float glass)	non-coated	20	LW	0.97	14
Gold	polished	130	T	0.018	1

**Table 33.1** T: Total spectrum; SW: 2–5 µm; LW: 8–14 µm, LLW: 6.5–20 µm; 1: Material; 2: Specification; 3: Temperature in °C; 4: Spectrum; 5: Emissivity; 6: Reference (continued)

1	2	3	4	5	6
Gold	polished, carefully	200–600	T	0.02–0.03	1
Gold	polished, highly	100	T	0.02	2
Granite	polished	20	LLW	0.849	8
Granite	rough	21	LLW	0.879	8
Granite	rough, 4 different samples	70	SW	0.95–0.97	9
Granite	rough, 4 different samples	70	LW	0.77–0.87	9
Gypsum		20	T	0.8–0.9	1
Ice: See Water					
Iron and steel	cold rolled	70	SW	0.20	9
Iron and steel	cold rolled	70	LW	0.09	9
Iron and steel	covered with red rust	20	T	0.61–0.85	1
Iron and steel	electrolytic	100	T	0.05	4
Iron and steel	electrolytic	22	T	0.05	4
Iron and steel	electrolytic	260	T	0.07	4
Iron and steel	electrolytic, carefully polished	175–225	T	0.05–0.06	1
Iron and steel	freshly worked with emery	20	T	0.24	1
Iron and steel	ground sheet	950–1100	T	0.55–0.61	1
Iron and steel	heavily rusted sheet	20	T	0.69	2
Iron and steel	hot rolled	130	T	0.60	1
Iron and steel	hot rolled	20	T	0.77	1
Iron and steel	oxidized	100	T	0.74	4
Iron and steel	oxidized	100	T	0.74	1
Iron and steel	oxidized	1227	T	0.89	4
Iron and steel	oxidized	125–525	T	0.78–0.82	1
Iron and steel	oxidized	200	T	0.79	2
Iron and steel	oxidized	200–600	T	0.80	1
Iron and steel	oxidized strongly	50	T	0.88	1
Iron and steel	oxidized strongly	500	T	0.98	1
Iron and steel	polished	100	T	0.07	2
Iron and steel	polished	400–1000	T	0.14–0.38	1
Iron and steel	polished sheet	750–1050	T	0.52–0.56	1
Iron and steel	rolled sheet	50	T	0.56	1
Iron and steel	rolled, freshly	20	T	0.24	1
Iron and steel	rough, plane surface	50	T	0.95–0.98	1
Iron and steel	rusted red, sheet	22	T	0.69	4
Iron and steel	rusted, heavily	17	SW	0.96	5
Iron and steel	rusty, red	20	T	0.69	1
Iron and steel	shiny oxide layer, sheet,	20	T	0.82	1

**Table 33.1** T: Total spectrum; SW: 2–5  $\mu\text{m}$ ; LW: 8–14  $\mu\text{m}$ , LLW: 6.5–20  $\mu\text{m}$ ; 1: Material; 2: Specification; 3: Temperature in  $^{\circ}\text{C}$ ; 4: Spectrum; 5: Emissivity; 6: Reference (continued)

1	2	3	4	5	6
Iron and steel	shiny, etched	150	T	0.16	1
Iron and steel	wrought, carefully polished	40–250	T	0.28	1
Iron galvanized	heavily oxidized	70	SW	0.64	9
Iron galvanized	heavily oxidized	70	LW	0.85	9
Iron galvanized	sheet	92	T	0.07	4
Iron galvanized	sheet, burnished	30	T	0.23	1
Iron galvanized	sheet, oxidized	20	T	0.28	1
Iron tinned	sheet	24	T	0.064	4
Iron, cast	casting	50	T	0.81	1
Iron, cast	ingots	1000	T	0.95	1
Iron, cast	liquid	1300	T	0.28	1
Iron, cast	machined	800–1000	T	0.60–0.70	1
Iron, cast	oxidized	100	T	0.64	2
Iron, cast	oxidized	260	T	0.66	4
Iron, cast	oxidized	38	T	0.63	4
Iron, cast	oxidized	538	T	0.76	4
Iron, cast	oxidized at 600 $^{\circ}\text{C}$	200–600	T	0.64–0.78	1
Iron, cast	polished	200	T	0.21	1
Iron, cast	polished	38	T	0.21	4
Iron, cast	polished	40	T	0.21	2
Iron, cast	unworked	900–1100	T	0.87–0.95	1
Krylon Ultra-flat black 1602	Flat black	Room temperature up to 175	LW	$\approx 0.96$	12
Krylon Ultra-flat black 1602	Flat black	Room temperature up to 175	MW	$\approx 0.97$	12
Lacquer	3 colors sprayed on Aluminum	70	SW	0.50–0.53	9
Lacquer	3 colors sprayed on Aluminum	70	LW	0.92–0.94	9
Lacquer	Aluminum on rough surface	20	T	0.4	1
Lacquer	bakelite	80	T	0.83	1
Lacquer	black, dull	40–100	T	0.96–0.98	1
Lacquer	black, matte	100	T	0.97	2
Lacquer	black, shiny, sprayed on iron	20	T	0.87	1
Lacquer	heat-resistant	100	T	0.92	1
Lacquer	white	100	T	0.92	2
Lacquer	white	40–100	T	0.8–0.95	1
Lead	oxidized at 200 $^{\circ}\text{C}$	200	T	0.63	1
Lead	oxidized, gray	20	T	0.28	1
Lead	oxidized, gray	22	T	0.28	4
Lead	shiny	250	T	0.08	1

**Table 33.1** T: Total spectrum; SW: 2–5 µm; LW: 8–14 µm, LLW: 6.5–20 µm; 1: Material; 2: Specification; 3: Temperature in °C; 4: Spectrum; 5: Emissivity; 6: Reference (continued)

1	2	3	4	5	6
Lead	unoxidized, polished	100	T	0.05	4
Lead red		100	T	0.93	4
Lead red, powder		100	T	0.93	1
Leather	tanned		T	0.75–0.80	1
Lime			T	0.3–0.4	1
Magnesium		22	T	0.07	4
Magnesium		260	T	0.13	4
Magnesium		538	T	0.18	4
Magnesium	polished	20	T	0.07	2
Magnesium powder			T	0.86	1
Molybdenum		1500–2200	T	0.19–0.26	1
Molybdenum		600–1000	T	0.08–0.13	1
Molybdenum	filament	700–2500	T	0.1–0.3	1
Mortar		17	SW	0.87	5
Mortar	dry	36	SW	0.94	7
Nextel Velvet 811-21 Black	Flat black	–60–150	LW	> 0.97	10 and 11
Nichrome	rolled	700	T	0.25	1
Nichrome	sandblasted	700	T	0.70	1
Nichrome	wire, clean	50	T	0.65	1
Nichrome	wire, clean	500–1000	T	0.71–0.79	1
Nichrome	wire, oxidized	50–500	T	0.95–0.98	1
Nickel	bright matte	122	T	0.041	4
Nickel	commercially pure, polished	100	T	0.045	1
Nickel	commercially pure, polished	200–400	T	0.07–0.09	1
Nickel	electrolytic	22	T	0.04	4
Nickel	electrolytic	260	T	0.07	4
Nickel	electrolytic	38	T	0.06	4
Nickel	electrolytic	538	T	0.10	4
Nickel	electroplated on iron, polished	22	T	0.045	4
Nickel	electroplated on iron, unpolished	20	T	0.11–0.40	1
Nickel	electroplated on iron, unpolished	22	T	0.11	4
Nickel	electroplated, polished	20	T	0.05	2
Nickel	oxidized	1227	T	0.85	4
Nickel	oxidized	200	T	0.37	2
Nickel	oxidized	227	T	0.37	4
Nickel	oxidized at 600°C	200–600	T	0.37–0.48	1
Nickel	polished	122	T	0.045	4



**Table 33.1** T: Total spectrum; SW: 2–5  $\mu\text{m}$ ; LW: 8–14  $\mu\text{m}$ , LLW: 6.5–20  $\mu\text{m}$ ; 1: Material; 2: Specification; 3: Temperature in  $^{\circ}\text{C}$ ; 4: Spectrum; 5: Emissivity; 6: Reference (continued)

1	2	3	4	5	6
Nickel	wire	200–1000	T	0.1–0.2	1
Nickel oxide		1000–1250	T	0.75–0.86	1
Nickel oxide		500–650	T	0.52–0.59	1
Oil, lubricating	0.025 mm film	20	T	0.27	2
Oil, lubricating	0.050 mm film	20	T	0.46	2
Oil, lubricating	0.125 mm film	20	T	0.72	2
Oil, lubricating	film on Ni base: Ni base only	20	T	0.05	2
Oil, lubricating	thick coating	20	T	0.82	2
Paint	8 different colors and qualities	70	SW	0.88–0.96	9
Paint	8 different colors and qualities	70	LW	0.92–0.94	9
Paint	Aluminum, vari- ous ages	50–100	T	0.27–0.67	1
Paint	cadmium yellow		T	0.28–0.33	1
Paint	chrome green		T	0.65–0.70	1
Paint	cobalt blue		T	0.7–0.8	1
Paint	oil	17	SW	0.87	5
Paint	oil based, aver- age of 16 colors	100	T	0.94	2
Paint	oil, black flat	20	SW	0.94	6
Paint	oil, black gloss	20	SW	0.92	6
Paint	oil, gray flat	20	SW	0.97	6
Paint	oil, gray gloss	20	SW	0.96	6
Paint	oil, various colors	100	T	0.92–0.96	1
Paint	plastic, black	20	SW	0.95	6
Paint	plastic, white	20	SW	0.84	6
Paper	4 different colors	70	SW	0.68–0.74	9
Paper	4 different colors	70	LW	0.92–0.94	9
Paper	black		T	0.90	1
Paper	black, dull		T	0.94	1
Paper	black, dull	70	SW	0.86	9
Paper	black, dull	70	LW	0.89	9
Paper	blue, dark		T	0.84	1
Paper	coated with black lacquer		T	0.93	1
Paper	green		T	0.85	1
Paper	red		T	0.76	1
Paper	white	20	T	0.7–0.9	1
Paper	white bond	20	T	0.93	2
Paper	white, 3 different glosses	70	SW	0.76–0.78	9
Paper	white, 3 different glosses	70	LW	0.88–0.90	9

**Table 33.1** T: Total spectrum; SW: 2–5  $\mu\text{m}$ ; LW: 8–14  $\mu\text{m}$ , LLW: 6.5–20  $\mu\text{m}$ ; 1: Material; 2: Specification; 3: Temperature in  $^{\circ}\text{C}$ ; 4: Spectrum; 5: Emissivity; 6: Reference (continued)

1	2	3	4	5	6
Paper	yellow		T	0.72	1
Plaster		17	SW	0.86	5
Plaster	plasterboard, untreated	20	SW	0.90	6
Plaster	rough coat	20	T	0.91	2
Plastic	glass fibre laminate (printed circ. board)	70	SW	0.94	9
Plastic	glass fibre laminate (printed circ. board)	70	LW	0.91	9
Plastic	polyurethane isolation board	70	LW	0.55	9
Plastic	polyurethane isolation board	70	SW	0.29	9
Plastic	PVC, plastic floor, dull, structured	70	SW	0.94	9
Plastic	PVC, plastic floor, dull, structured	70	LW	0.93	9
Platinum		100	T	0.05	4
Platinum		1000–1500	T	0.14–0.18	1
Platinum		1094	T	0.18	4
Platinum		17	T	0.016	4
Platinum		22	T	0.03	4
Platinum		260	T	0.06	4
Platinum		538	T	0.10	4
Platinum	pure, polished	200–600	T	0.05–0.10	1
Platinum	ribbon	900–1100	T	0.12–0.17	1
Platinum	wire	1400	T	0.18	1
Platinum	wire	500–1000	T	0.10–0.16	1
Platinum	wire	50–200	T	0.06–0.07	1
Porcelain	glazed	20	T	0.92	1
Porcelain	white, shiny		T	0.70–0.75	1
Rubber	hard	20	T	0.95	1
Rubber	soft, gray, rough	20	T	0.95	1
Sand			T	0.60	1
Sand		20	T	0.90	2
Sandstone	polished	19	LLW	0.909	8
Sandstone	rough	19	LLW	0.935	8
Silver	polished	100	T	0.03	2
Silver	pure, polished	200–600	T	0.02–0.03	1
Skin	human	32	T	0.98	2
Slag	boiler	0–100	T	0.97–0.93	1
Slag	boiler	1400–1800	T	0.69–0.67	1
Slag	boiler	200–500	T	0.89–0.78	1
Slag	boiler	600–1200	T	0.76–0.70	1
Snow: See Water					

**Table 33.1** T: Total spectrum; SW: 2–5  $\mu\text{m}$ ; LW: 8–14  $\mu\text{m}$ , LLW: 6.5–20  $\mu\text{m}$ ; 1: Material; 2: Specification; 3: Temperature in  $^{\circ}\text{C}$ ; 4: Spectrum; 5: Emissivity; 6: Reference (continued)

1	2	3	4	5	6
Soil	dry	20	T	0.92	2
Soil	saturated with water	20	T	0.95	2
Stainless steel	alloy, 8% Ni, 18% Cr	500	T	0.35	1
Stainless steel	rolled	700	T	0.45	1
Stainless steel	sandblasted	700	T	0.70	1
Stainless steel	sheet, polished	70	SW	0.18	9
Stainless steel	sheet, polished	70	LW	0.14	9
Stainless steel	sheet, untreated, somewhat scratched	70	SW	0.30	9
Stainless steel	sheet, untreated, somewhat scratched	70	LW	0.28	9
Stainless steel	type 18-8, buffed	20	T	0.16	2
Stainless steel	type 18-8, oxidized at 800 $^{\circ}\text{C}$	60	T	0.85	2
Stucco	rough, lime	10–90	T	0.91	1
Styrofoam	insulation	37	SW	0.60	7
Tar			T	0.79–0.84	1
Tar	paper	20	T	0.91–0.93	1
Tile	glazed	17	SW	0.94	5
Tin	burnished	20–50	T	0.04–0.06	1
Tin	tin-plated sheet iron	100	T	0.07	2
Titanium	oxidized at 540 $^{\circ}\text{C}$	1000	T	0.60	1
Titanium	oxidized at 540 $^{\circ}\text{C}$	200	T	0.40	1
Titanium	oxidized at 540 $^{\circ}\text{C}$	500	T	0.50	1
Titanium	polished	1000	T	0.36	1
Titanium	polished	200	T	0.15	1
Titanium	polished	500	T	0.20	1
Tungsten		1500–2200	T	0.24–0.31	1
Tungsten		200	T	0.05	1
Tungsten		600–1000	T	0.1–0.16	1
Tungsten	filament	3300	T	0.39	1
Varnish	flat	20	SW	0.93	6
Varnish	on oak parquet floor	70	SW	0.90	9
Varnish	on oak parquet floor	70	LW	0.90–0.93	9
Wallpaper	slight pattern, light gray	20	SW	0.85	6
Wallpaper	slight pattern, red	20	SW	0.90	6
Water	distilled	20	T	0.96	2
Water	frost crystals	–10	T	0.98	2
Water	ice, covered with heavy frost	0	T	0.98	1

**Table 33.1** T: Total spectrum; SW: 2–5  $\mu\text{m}$ ; LW: 8–14  $\mu\text{m}$ , LLW: 6.5–20  $\mu\text{m}$ ; 1: Material; 2: Specification; 3: Temperature in  $^{\circ}\text{C}$ ; 4: Spectrum; 5: Emissivity; 6: Reference (continued)

1	2	3	4	5	6
Water	ice, smooth	0	T	0.97	1
Water	ice, smooth	-10	T	0.96	2
Water	layer >0.1 mm thick	0–100	T	0.95–0.98	1
Water	snow		T	0.8	1
Water	snow	-10	T	0.85	2
Wood		17	SW	0.98	5
Wood		19	LLW	0.962	8
Wood	ground		T	0.5–0.7	1
Wood	pine, 4 different samples	70	SW	0.67–0.75	9
Wood	pine, 4 different samples	70	LW	0.81–0.89	9
Wood	planed	20	T	0.8–0.9	1
Wood	planed oak	20	T	0.90	2
Wood	planed oak	70	SW	0.77	9
Wood	planed oak	70	LW	0.88	9
Wood	plywood, smooth, dry	36	SW	0.82	7
Wood	plywood, untreated	20	SW	0.83	6
Wood	white, damp	20	T	0.7–0.8	1
Zinc	oxidized at 400 $^{\circ}\text{C}$	400	T	0.11	1
Zinc	oxidized surface	1000–1200	T	0.50–0.60	1
Zinc	polished	200–300	T	0.04–0.05	1
Zinc	sheet	50	T	0.20	1

# **EtherNet/IP and Modbus TCP Object Models**

---

# **FLIR Systems**

## **EtherNet/IP and Modbus TCP Object Models**

Object Model revision: 1.22

Real Time Automation, Inc.  
150 S. Sunnyslope Rd. Suite 130  
Brookfield, WI 53005  
262.439.4999 (V) 262.439.4989 (F)  
[www.rtaautomation.com](http://www.rtaautomation.com)

## Chapter 1 Introduction to EtherNet/IP

EtherNet/IP™ (EIP) is a high-level industrial application layer protocol for industrial automation applications. Built on the standard TCP/IP protocol suite, EIP uses all the traditional Ethernet hardware and software to define an application layer protocol that structures the task of configuring, accessing and controlling industrial automation devices. Ethernet/IP classifies Ethernet nodes as predefined device types with specific behaviors. The set of device types and the EIP application layer protocol is based on the Control and Information Protocol (CIP) layer used in both DeviceNet™ and ControlNet™. Building on these widely used protocol suites, EtherNet/IP for the first time provides a seamless integrated system from the sensor-actuator network to the controller and enterprise networks. EIP provides a wide-ranging, comprehensive, certifiable standard suitable to a wide variety of automation devices.

### ***EtherNet/IP uses the tools and technologies of traditional Ethernet***

EtherNet/IP uses all the transport and control protocols used in traditional Ethernet, including the Transport Control Protocol (TCP), the Internet Protocol (IP), and the media access and signaling technologies found in off-the-shelf Ethernet interface cards. Building on these standard PC technologies means that EIP works transparently with all the standard off-the-shelf Ethernet devices found in today's marketplace. It also means that EIP can be easily supported on standard PCs and all their derivatives. Even more importantly, basing EIP on a standard technology platform ensures that EIP will move forward as the base technologies evolve.

### ***EtherNet/IP is a certifiable standard***

EtherNet/IP ensures a comprehensive, consistent standard by careful, multi-vendor attention to the specification and through certified test labs as is used for other well-known communication standards like DeviceNet and ControlNet. The EtherNet/IP Certification program ensures the consistency and quality of field devices.

### ***EIP is built on a widely accepted protocol layer***

EIP is constructed from a very widely implemented standard used in DeviceNet and ControlNet called the Control and Information Protocol (CIP). This standard organizes networked devices as a collection of objects. It defines the access, object behavior and extensions which allow widely disparate devices to be accessed using a common mechanism. Over 500 vendors now support the CIP protocol in present day products. Using this technology in EIP means that EIP is based on a widely understood, widely implemented standard that does not require a new technology shakedown period.

## ***CIP – The Core of EtherNet/IP***

The Communications and Information Protocol (CIP) is a communications protocol for transferring automation data between two devices. In the CIP Protocol, every network device represents itself as a series of objects. Each object is simply a grouping of the related data values in a device. For example, every CIP device is required to make an Identity object available to the network. The identity object contains related identity data values called attributes. Attributes for the identity object include the vendor ID, date of manufacture, device serial number, and other identity data. CIP does not specify at all how this object data is implemented, only what data values or attributes must be supported and that these attributes must be available to other CIP devices.

The Identity object is an example of a required object. There are three types of objects defined by the CIP protocol; Required Object, Application Objects and Vendor Specific Objects. The collection of specific object for a particular device is known as the device's **Object Model**.

## **REQUIRED OBJECTS**

Required objects are required by the specification to be included in every CIP device. These objects include the Identity object, a Message Router object and a Network object.

The identity object contains related identity data values called attributes. Attributes for the identity object include the vendor ID, date of manufacturer, device serial number, and other identity data.

The Message Router object is an object which routes explicit request messages from object to object in a device.

A Network object contains the physical connection data for the object. For a CIP device on DeviceNet, the network object contains the MacID and other data describing the interface to the CAN network. For EIP devices, the network object contains the IP address and other data describing the interface to the Ethernet port on the device.

## **APPLICATION OBJECTS**

Application objects are the objects that define the data encapsulated by the device. These objects are specific to the device type and function. For example, a Motor object on a Drive System has attributes describing the frequency, current rating and motor size. An Analog Input object on an I/O device has attributes that define the type, resolution and current value for the analog input.

These application layer objects are predefined for a large number of common device types. All CIP devices with the same device type (Drive Systems, Motion Control, Valve Transducer...etc) must contain the identical series of application objects. The series of application objects for a particular device type is known as the device profile. A large number of profiles for many device types have been defined. Supporting a device profile allows a user to easily understand and switch from a vendor of one device type to another vendor with that same device type.

A device vendor can also group Application Layer Objects into assembly objects. These super objects contain attributes of one or more Application Layer Objects. Assembly objects form a convenient package for transporting data between devices. For example, a vendor of a



Temperature Controller with multiple temperature loops may define assemblies for each of the temperature loops and an assembly with data from all temperature loops. The user can then pick the assembly that is most suited for the application and how often to access each assembly. For example, one temperature assembly may be configured to report every time it changes state while the second may be configured to report every one-second regardless of a change in state.

Assemblies are usually predefined by the vendor, but CIP also defines a mechanism in which the user can dynamically create an assembly from application layer object attributes.

## **VENDOR SPECIFIC OBJECTS**

Objects not found in the profile for a device class are termed Vendor Specific. The vendor includes these objects as additional features of the device. The CIP protocol provides access to these vendor extension objects in exactly the same method as either application or required objects. This data is strictly of the vendor's choosing and is organized in whatever method makes sense to the device vendor.

In addition to specifying how device data is represented to the network, the CIP protocol specifies a number of different ways in which that data can be accessed such as cyclic, polled and change-of-state.

## **ADVANTAGES TO EIP**

The advantages of the CIP protocol layer over EtherNet/IP are numerous. The consistent device access means that a single configuration tool can configure CIP devices on different networks from a single access point without using vendor specific software. The classification of all devices as objects decreases the training and startup required when new devices are brought online. EIP provides improved response time and greater data throughput than DeviceNet and ControlNet. EIP links devices from the sensor bus level to the control level to the enterprise level with a consistent application layer interface.

## **PLC COMMUNICATION OVER ETHERNET/IP**

Two types of devices communicate over EtherNet/IP. One type, Adapters, are the devices that move I/O between the physical world and the EtherNet/IP network. Adapter devices are "end" devices in a network. Valves, Drives, I/O Devices and Cameras are typically Adapter devices. The Flir camera is an Adapter device. The other device is a Scanners device. Scanners open connections and send outputs to one or more Adapter devices. A Programmable Controller is a typically a Scanner device in an EtherNet/IP network.

Scanner devices send outputs to one or more Adapter devices. Adapter devices send inputs to a Scanner. The Output Assembly Instances defined later in this document defines the outputs sent from the Scanner device to the FLIR Camera. The Input Assembly Instance defined later in this document defines the inputs sent from the Camera to the Scanner device.

## ***EtherNet/IP Electronic Data Sheets Files***

Electronic Data Sheets (EDS) are simply ASCII files that describe how a device can be used on an EtherNet/IP network. It describes the objects, attributes and services available in the device.

At the minimum, an EDS file conveys the identity information required for a network tool to recognize the device. For EtherNet/IP Scanners, the EDS File conveys information on the EtherNet/IP Adapters I/O messages. It details the specifics of the Input Message produced by the EtherNet/IP Adapter and the Output message consumed by the Adapter.

The amount of information stored in an EDS file varies from device to device. Some manufacturers store the minimum amount of information in the EDS file while other devices store all the details of every object and attribute in the device.

EDS files are sometimes shipped with a device in some media format like a CD or made available on the device manufacturers website. Some devices with extended data storage contain the EDS file internally within the device.

## ***EDS File Structure***

- File Section – Administers the EDS file. Sometimes the URL keyword provides a link to a website where the latest version of the EDS can be found.
- Device Section – Provides keying information that matches the EDS to a particular revision of a device. The first three attributes of the Identity Object (Object #1) are used by network tools to verify that this EDS file (Vendor, Model,...etc) plus the device revision matches the information found in the device. The network tool will not connect to a device unless all four Identity Object Parameters match. Some people mistakenly believe that the Minor Revision number is included in this match but that is not true.
- Device Classification Section – Classifies the EDS for an EtherNet/IP network. The Device Classification Section is required for all EtherNet/IP devices.
- Connection Manager Section – Identifies the CIP connections that are available in the device. This section indicates to the EtherNet/IP Scanner the Triggers and Transports available in the device. If a device supports multiple connections then every connection must be detailed in this section. Only connections that are specified in this section can be used in an EDS-based configuration tool.
- Assembly, Params and ParamClass section – These sections are filled in as needed. For values that are limited to a limited to a defined set of values, Enumeration can be used to specify those values. Value ranges can be specified here also for Configurable parameters.
- Capacity Section – This section indicates the number of connections available in the device and the connection speeds
- Port Section – This section describes the Ethernet port. It is only applicable to devices that perform CIP routing. It is unnecessary for devices containing a single CIP port.

### ***EtherNet/IP Add-on Profiles***

The RSLogix5000 Programming Tool from Rockwell Automation uses EtherNet/IP EDS files to understand the Object Model of an EtherNet/IP device. The EDS file describes what data is contained in the messages received from the EtherNet/IP device and what data it should send to the EtherNet/IP device. The addition of an EDS file to the standard RSLogix5000 device library is called an Add-on Profile by Rockwell Automation.

EDS files can be loaded into the RSLogix5000 programming tool in one of two ways. EDS files from vendors which are not highly integrated with Rockwell Automation are loaded manually. EDS files from vendors which are highly integrated with Rockwell Automation, like Flir, are automatically loaded and available with the more recent versions of RSLogix5000.

## Chapter 2 EtherNet/IP Object Model

Table 2-1 describes data types used in this Object Model.

**Table 2-1** Data types

<b>Data Type</b>	<b>Description</b>
USINT	Unsigned Short Integer (8-bit)
UINT	Unsigned Integer (16-bit)
UDINT	Unsigned Double Integer (32-bit)
DINT	Signed Double Integer (32-bit)
INT	Signed Integer (16-bit)
STRING	Character String (1 byte per character)
SHORT STRING $mn$	Character String (1 <sup>st</sup> byte is length; up to $mn$ characters)
BYTE	Bit String (8-bits)
WORD	Bit String (16-bits)
DWORD	Bit String (32-bits)
REAL	IEEE 32-bit Single Precision Floating Point

The following sections list each object's required attributes and services, if any.

### IMPORTANT NOTES:

- All Double Precision Floating Point Values in the camera will be converted to Single Precision Floating Point Values over EtherNet/IP.
- We are assuming that every call to the camera is a blocking call. Verify that the I/O RPI is large enough so no connections are dropped.
- EtherNet/IP is a Little-Endian protocol, meaning that the data order is least significant byte to most significant byte.

# Objects included in Model

Chapter 1	Introduction to EtherNet/IP .....	2
	Ethernet/IP uses the tools and technologies of traditional Ethernet .....	2
	EtherNet/IP is a certifiable standard .....	2
	EIP is built on a widely accepted protocol layer .....	2
	CIP – The Core of EtherNet/IP .....	3
	REQUIRED OBJECTS .....	3
	APPLICATION OBJECTS .....	3
	VENDOR SPECIFIC OBJECTS .....	4
	ADVANTAGES TO EIP .....	4
	PLC COMMUNICATION OVER ETHERNET/IP .....	4
	EtherNet/IP Electronic Data Sheets Files .....	5
	EDS File Structure .....	5
	EtherNet/IP Add-on Profiles .....	6
Chapter 2	EtherNet/IP Object Model .....	7
1.1	Identity Object (01 <sub>HEX</sub> - 1 Instance) .....	9
1.2	Message Router Object (02 <sub>HEX</sub> - 0 Instances) .....	10
1.3	Assembly Object (04 <sub>HEX</sub> - 8 Instances) .....	10
1.4	Connection Manager Object (06 <sub>HEX</sub> : 0 Instances) .....	18
1.5	PCCC Object (67 <sub>HEX</sub> - 1 Instance) .....	19
1.6	TCP Object (F5hex- 1 instance) .....	27
1.7	Ethernet Link Object (F6 <sub>HEX</sub> - 1 Instance) .....	28
1.8	System Command Object (64 <sub>HEX</sub> - 1 Instance) .....	29
1.9	Camera Control Command Object (65 <sub>HEX</sub> - 1 Instance) .....	30
1.10	Temperature Control Object (66 <sub>HEX</sub> . n Instances) .....	34
1.11	Image Control Commands Object (67 <sub>HEX</sub> - 1 Instance) .....	37
1.12	Isotherm Control Commands Object (68 <sub>HEX</sub> - 1 Instance) .....	40
1.13	Image File Storage Object (69 <sub>HEX</sub> - 1 Instance) .....	42
1.14	Alarm Settings Object (6A <sub>HEX</sub> - 9 Instances) .....	43
1.15	Object Parameters Object (6B <sub>HEX</sub> - 1 Instance) .....	45
1.16	Spot Meter Object (6C <sub>HEX</sub> - 20 Instances) .....	47

1.17 Box Object (6D<sub>HEX</sub>- 20 Instances) ..... 50

1.18 Temperature Difference Object (6E<sub>HEX</sub>- 6 Instances) ..... 56

1.19 Physical I/O Object (6F<sub>HEX</sub>- 1 Instance) ..... 58

1.20 Pass Through Object (70<sub>HEX</sub>- 1 Instance) ..... 60

Appendix A – Additional PCCC Mappings ..... 63

    Additional Integer (N) mappings ..... 63

    Additional Float (F) mappings ..... 64

Appendix B – Modbus TCP Assembly Mappings ..... 65

    Mapping 1 - Write Assembly Mapping ..... 65

    Mapping 2 - Read Assembly Values ..... 66

    Mapping 3 - Read Assembly Values ..... 69

Appendix C – Additional Modbus TCP Mappings ..... 72

    Additional Modbus mappings ..... 72

**1.1 Identity Object (01<sub>HEX</sub>- 1 Instance)**

The following tables contain the attribute, status, and common services information for the Identity Object.

Table 2-2 Identity Object (01<sub>HEX</sub>- 1 Instance)

Instance	Attribute ID	Name	Data Type	Data value	Access rule
Class (Instance 0)	1	Revision	UINT	1	Get
Instance 1	1	Vendor number	UINT	1161	Get
	2	Device type	UINT	43	Get
	3	Product code number	UINT	320 = “FLIR A310” 321 = “FLIR Ax8”	Get
	4	Product major revision Product minor revision	USINT USINT	02 40	Get
	5	Status	WORD	Always 0	Get

Instance	Attribute ID	Name	Data Type	Data value	Access rule
	6	Serial number	UDINT	Unique 32 bit value	Get
	7	Product name	SHORT STRING32	Depends on camera model.	Get

Table 2-3 Identity Object's common services

Service code	Implemented for		Service name
	Class level	Instance level	
05 <sub>Hex</sub>	No	Yes	Reset <sup>1</sup>
0E <sub>Hex</sub>	Yes	Yes	Get_Attribute_Single

### 1.2 Message Router Object (02<sub>HEX</sub> - 0 Instances)

\*\*\*No supported services or attributes\*\*\*

### 1.3 Assembly Object (04<sub>HEX</sub> - 8 Instances)

The following tables contain the attribute, instance, data mapping, and common services information for the Assembly Object.

Table 2-4 Assembly Object (04<sub>HEX</sub> - 2 Instances)

Instance	Attribute ID	Name	Data Type	Data Value	Access Rule
Class (Instance 0)	1	Revision	UINT	2	Get
	2	Max instance	UINT	0x81	Get

<sup>1</sup> If the Reset Service Code is sent with just a Class ID of 0x01 and Instance ID of 0x01, then a Normal Reset will occur. If the Reset Service Code is sent with a Class ID of 0x01, Instance ID of 0x01, and an additional value of 1, then the camera will resume with Factory Default settings.

Instance	Attribute ID	Name	Data Type	Data Value	Access Rule							
Output 0x70	3	Output Data				Get/Set						
		Byte	Bit 7	Bit 6	Bit 5		Bit 4	Bit 3	Bit 2	Bit 1	Bit 0	
		0	Reserved	Force Image One Shot	Save Image		One Time Image Auto Adjust	Auto Focus Fast	Auto Focus Full	Force NUC	Auto NUC	
		1	Reserved	Reserved	Image Live		Image Freeze	Reserved	Reserved	DO 2	DO 1	
		2	Atmospheric Temp. Graphic	Reflected Temp. Graphic	Distance Graphic		Emissivity Graphic	Date/Time Graphic	Scale Graphic	Camera Label Graphic	Enable Overlay Graphics	
		3	Reserved	Reserved	Reserved		Reserved	Reserved	Measurement Mark Graphic	Lens Graphic	Relative Humidity Graphic	
		Output Data										
		Byte	Bit 7	Bit 6	Bit 5		Bit 4	Bit 3	Bit 2	Bit 1	Bit 0	
		0	Reserved	Force Image One Shot	Save Image		One Time Image Auto Adjust	Auto Focus Fast	Auto Focus Full	Force NUC	Auto NUC	
		1	Reserved	Reserved	Image Live		Image Freeze	Reserved	Reserved	DO 2	DO 1	
		2	Atmospheric Temp. Graphic	Reflected Temp. Graphic	Distance Graphic		Emissivity Graphic	Date/Time Graphic	Scale Graphic	Camera Label Graphic	Enable Overlay Graphics	
		3	Reserved	Reserved	Reserved		Reserved	Reserved	Measurement Mark Graphic	Lens Graphic	Relative Humidity Graphic	
		4	Reserved	Reserved	Reserved		Reserved	Reserved	Reserved	Reserved	Reserved	
5	Set Configuration Preset (RESERVED FOR FUTURE USE)											
6	Reserved	Reserved	Reserved	Reserved	Reserved	Reserved	Reserved	Reserved	Reserved			
7	Reserved	Reserved	Reserved	Reserved	Reserved	Reserved	Reserved	Reserved	Reserved			
Output 0x71	3	Output Data				Get/Set						
		Byte	Bit 7	Bit 6	Bit 5		Bit 4	Bit 3	Bit 2	Bit 1	Bit 0	
		0	Reserved	Force Image One Shot	Save Image		One Time Image Auto Adjust	Auto Focus Fast	Auto Focus Full	Force NUC	Auto NUC	
		1	Reserved	Reserved	Image Live		Image Freeze	Reserved	Reserved	DO 2	DO 1	
		2	Atmospheric Temp. Graphic	Reflected Temp. Graphic	Distance Graphic		Emissivity Graphic	Date/Time Graphic	Scale Graphic	Camera Label Graphic	Enable Overlay Graphics	
		3	Reserved	Reserved	Reserved		Reserved	Reserved	Measurement Mark Graphic	Lens Graphic	Relative Humidity Graphic	
		4	Reserved	Reserved	Reserved		Reserved	Reserved	Reserved	Reserved	Reserved	
		5	Set Configuration Preset (RESERVED FOR FUTURE USE)									
		6	Reserved	Reserved	Reserved		Reserved	Reserved	Reserved	Reserved	Reserved	Reserved
		7	Reserved	Reserved	Reserved		Reserved	Reserved	Reserved	Reserved	Reserved	Reserved



FLIR Systems Object Model version 1.22

Input		Input Data										Get
Byte	Bit 7	Bit 6	Bit 5	Bit 4	Bit 3	Bit 2	Bit 1	Bit 0				
0x64	Reserved	Force Image One Shot	Save Image	One Time Image Auto Adjust	Auto Focus Fast	Auto Focus Full	Force NUC	Auto NUC				
1	Disable Alarms <sup>1</sup>	Reserved	Image Live	Image Freeze	DI 2	DI 1	DO 2	DO 1				
2	Atmospheric Temp. Graphic	Reflected Temp. Graphic	Distance Graphic	Emissivity Graphic	Date/Time Graphic	Scale Graphic	Camera Label Graphic	Enable Overlay Graphics				
3	Reserved	Reserved	Reserved	Reserved	Reserved	Measurement Mark Graphic	Lens Graphic	Relative Humidity Graphic				
4	Alarm 8	Alarm 7	Alarm 6	Alarm 5	Alarm 4	Alarm 3	Alarm 2	Alarm 1				
5	Set Configuration Preset (RESERVED FOR FUTURE USE)											
6	Reserved	Reserved	Reserved	Reserved	Reserved	Reserved	Reserved	Reserved				
7	Reserved	Reserved	Reserved	Reserved	Reserved	Reserved	Reserved	Reserved				
8-11	Delta Temperature 1											
12-15	Delta Temperature 2											
16-19	Delta Temperature 3											
20-23	Delta Temperature 4											
24-27	Delta Temperature 5											
28-31	Delta Temperature 6											
32-35	Internal Camera Temperature											
36-39	Spot 1 Temperature											
40-43	Box 1 Min Temperature											
44-47	Box 1 Max Temperature											
48-51	Box 1 Average Temperature											
52	Spot 1 Temperature Valid State											
53	Box 1 Min Temperature Valid State											
54	Box 1 Max Temperature Valid State											
55	Box 1 Avg Temperature Valid State											
56-59	Spot 2 Temperature											
60-63	Box 2 Min Temperature											
64-67	Box 2 Max Temperature											
68-71	Box 2 Average Temperature											
72	Spot 2 Temperature Valid State											
73	Box 2 Min Temperature Valid State											
74	Box 2 Max Temperature Valid State											
75	Box 2 Avg Temperature Valid State											
76-79	Spot 3 Temperature											
80-83	Box 3 Min Temperature											
84-87	Box 3 Max Temperature											
88-91	Box 3 Average Temperature											

<sup>1</sup> This alarm is the BATCH alarm. It has the ability to enable or disable all the other 8 alarms.

FLIR Systems Object Model version 1.22

Input 0x64 (cont)	3	92	Spot 3 Temperature Valid State									Get	
		93	Box 3 Min Temperature Valid State										
		94	Box 3 Max Temperature Valid State										
		95	Box 3 Avg Temperature Valid State										
		96-99	Spot 4 Temperature										
		100-103	Box 4 Min Temperature										
		104-107	Box 4 Max Temperature										
		108-111	Box 4 Average Temperature										
		112	Spot 4 Temperature Valid State										
		113	Box 4 Min Temperature Valid State										
		114	Box 4 Max Temperature Valid State										
		115	Box 4 Avg Temperature Valid State										
	Input 0x65	3	Input Data										Get
			Byte	Bit 7	Bit 6	Bit 5	Bit 4	Bit 3	Bit 2	Bit 1	Bit 0		
			0	Reserved	Force Image One Shot	Save Image	One Time Image Auto Adjust	Auto Focus Fast	Auto Focus Full	Force NUC	Auto NUC		
		1	Disable Alarm <sup>1</sup>	Reserved	Image Live	Image Freeze	DI 2	DI 1	DO 2	DO 1			
		2	Atmospheric Temp. Graphic	Reflected Temp. Graphic	Distance Graphic	Emissivity Graphic	Date/Time Graphic	Scale Graphic	Camera Label Graphic	Enable Overlay Graphics			
		3	Reserved	Reserved	Reserved	Reserved	Reserved	Measurement Mark Graphic	Lens Graphic	Relative Humidity Graphic			
		4	Alarm 8	Alarm 7	Alarm 6	Alarm 5	Alarm 4	Alarm 3	Alarm 2	Alarm 1			
		5	Set Configuration Preset (RESERVED FOR FUTURE USE)										
		6	Reserved	Reserved	Reserved	Reserved	Reserved	Reserved	Reserved	Reserved			
		7	Reserved	Reserved	Reserved	Reserved	Reserved	Reserved	Reserved	Reserved			
		8-11	Delta Temperature 1										
		12-15	Delta Temperature 2										
		16-19	Delta Temperature 3										
		20-23	Delta Temperature 4										
		24-27	Delta Temperature 5										
		28-31	Delta Temperature 6										
		32-35	Internal Camera Temperature										
		36-39	Spot 1 Temperature										
		40-43	Box 1 Min Temperature										
		44-47	Box 1 Max Temperature										
		48-51	Box 1 Average Temperature										
		52	Spot 1 Temperature Valid State										
		53	Box 1 Min Temperature Valid State										
		54	Box 1 Max Temperature Valid State										

<sup>1</sup> This alarm is the BATCH alarm. It has the ability to enable or disable all the other 8 alarms.

FLIR Systems Object Model version 1.22

Input		Get
0x65 (cont.)	3	
55	Box 1 Avg Temperature Valid State	
56-59	Spot 2 Temperature	
60-63	Box 2 Min Temperature	
64-67	Box 2 Max Temperature	
68-71	Box 2 Average Temperature	
72	Spot 2 Temperature Valid State	
73	Box 2 Min Temperature Valid State	
74	Box 2 Max Temperature Valid State	
75	Box 2 Avg Temperature Valid State	
76-79	Spot 3 Temperature	
80-83	Box 3 Min Temperature	
84-87	Box 3 Max Temperature	
88-91	Box 3 Average Temperature	
92	Spot 3 Temperature Valid State	
93	Box 3 Min Temperature Valid State	
94	Box 3 Max Temperature Valid State	
95	Box 3 Avg Temperature Valid State	
96-99	Spot 4 Temperature	
100-103	Box 4 Min Temperature	
104-107	Box 4 Max Temperature	
108-111	Box 4 Average Temperature	
112	Spot 4 Temperature Valid State	
113	Box 4 Min Temperature Valid State	
114	Box 4 Max Temperature Valid State	
115	Box 4 Avg Temperature Valid State	
116-135	.....Spot 5/ Box 5.....	
136-155	.....Spot 6/ Box 6.....	
156-175	.....Spot 7/ Box 7.....	
176-195	.....Spot 8/ Box 8.....	
196-215	.....Spot 9/ Box 9.....	
216-235	.....Spot 10/ Box 10.....	
236-255	.....Spot 11/ Box 11.....	
256-275	.....Spot 12/ Box 12.....	
276-295	.....Spot 13/ Box 13.....	
296-315	.....Spot 14/ Box 14.....	
316-335	.....Spot 15/ Box 15.....	
336-355	.....Spot 16/ Box 16.....	
356-375	.....Spot 17/ Box 17.....	
376-395	.....Spot 18/ Box 18.....	
396-415	.....Spot 19/ Box 19.....	

FLIR Systems Object Model version 1.22

Input 0x65 (cont.)	3	416-435	.....Spot 20/ Box 20.....	Get							
Input 0x66	3	Input Data									
		Byte	Bit 7	Bit 6	Bit 5	Bit 4	Bit 3	Bit 2	Bit 1	Bit 0	Get
		0-3	Delta Temperature 1								
		4-7	Delta Temperature 2								
		8-11	Delta Temperature 3								
		12-15	Delta Temperature 4								
		16-19	Delta Temperature 5								
		20-23	Delta Temperature 6								
		24-27	Internal Camera Temperature								
		28-31	Spot 1 Temperature								
		32-35	Box 1 Min Temperature								
		36-39	Box 1 Max Temperature								
		40-43	Box 1 Average Temperature								
		44	Spot 1 Temperature Valid State								
		45	Box 1 Min Temperature Valid State								
		46	Box 1 Max Temperature Valid State								
		47	Box 1 Avg Temperature Valid State								
		48-51	Spot 2 Temperature								
		52-55	Box 2 Min Temperature								
		56-59	Box 2 Max Temperature								
		60-63	Box 2 Average Temperature								
		64	Spot 2 Temperature Valid State								
		65	Box 2 Min Temperature Valid State								
		66	Box 2 Max Temperature Valid State								
		67	Box 2 Avg Temperature Valid State								
		68-71	Spot 3 Temperature								
		72-75	Box 3 Min Temperature								
		76-79	Box 3 Max Temperature								
		80-83	Box 3 Average Temperature								
		84	Spot 3 Temperature Valid State								
		85	Box 3 Min Temperature Valid State								
		86	Box 3 Max Temperature Valid State								
		87	Box 3 Avg Temperature Valid State								
		88-91	Spot 4 Temperature								
		92-95	Box 4 Min Temperature								
		96-99	Box 4 Max Temperature								
		100-103	Box 4 Average Temperature								

FLIR Systems Object Model version 1.22

Input <i>0x66</i> (cont.)	3	104	Spot 4 Temperature Valid State	Get								
		105	Box 4 Min Temperature Valid State									
		106	Box 4 Max Temperature Valid State									
		107	Box 4 Avg Temperature Valid State									
		Input Data										
Input <i>0x67</i>	3	Byte	Bit 7	Bit 6	Bit 5	Bit 4	Bit 3	Bit 2	Bit 1	Bit 0	Get	
		0-3	Delta Temperature 1									
		4-7	Delta Temperature 2									
		8-11	Delta Temperature 3									
		12-15	Delta Temperature 4									
		16-19	Delta Temperature 5									
		20-23	Delta Temperature 6									
		24-27	Internal Camera Temperature									
		28-31	Spot 1 Temperature									
		32-35	Box 1 Min Temperature									
		36-39	Box 1 Max Temperature									
		40-43	Box 1 Average Temperature									
		44	Spot 1 Temperature Valid State									
		45	Box 1 Min Temperature Valid State									
		46	Box 1 Max Temperature Valid State									
		47	Box 1 Avg Temperature Valid State									
		48-51	Spot 2 Temperature									
		52-55	Box 2 Min Temperature									
		56-59	Box 2 Max Temperature									
		60-63	Box 2 Average Temperature									
		64	Spot 2 Temperature Valid State									
		65	Box 2 Min Temperature Valid State									
		66	Box 2 Max Temperature Valid State									
		67	Box 2 Avg Temperature Valid State									
		68-71	Spot 3 Temperature									
		72-75	Box 3 Min Temperature									
		76-79	Box 3 Max Temperature									
		80-83	Box 3 Average Temperature									
		84	Spot 3 Temperature Valid State									
		85	Box 3 Min Temperature Valid State									
		86	Box 3 Max Temperature Valid State									
		87	Box 3 Avg Temperature Valid State									
		88-91	Spot 4 Temperature									

FLIR Systems Object Model version 1.22

Input 0x67 (cont.)	3	92-95	Box 4 Min Temperature	Get					
		96-99	Box 4 Max Temperature						
Input 0x68	3	100-103	Box 4 Average Temperature	Get					
		104	Spot 4 Temperature Valid State						
		105	Box 4 Min Temperature Valid State						
		106	Box 4 Max Temperature Valid State						
		107	Box 4 Avg Temperature Valid State						
		108-127	.....Spot 5/ Box 5.....						
		128-147	.....Spot 6/ Box 6.....						
		148-167	.....Spot 7/ Box 7.....						
		168-187	.....Spot 8/ Box 8.....						
		188-207	.....Spot 9/ Box 9.....						
		208-227	.....Spot 10/ Box 10.....						
		228-247	.....Spot 11/ Box 11.....						
		248-267	.....Spot 12/ Box 12.....						
		268-287	.....Spot 13/ Box 13.....						
		288-307	.....Spot 14/ Box 14.....						
		308-327	.....Spot 15/ Box 15.....						
		328-347	.....Spot 16/ Box 16.....						
		348-367	.....Spot 17/ Box 17.....						
		368-387	.....Spot 18/ Box 18.....						
		388-407	.....Spot 19/ Box 19.....						
408-427	.....Spot 20/ Box 20.....								
Input Data	3			Get					
Byte	Bit 7	Bit 6	Bit 5	Bit 4	Bit 3	Bit 2	Bit 1	Bit 0	
0	Reserved	Force Image One Shot	Save Image	One Time Image Auto Adjust	Auto Focus Fast	Auto Focus Full	Force NUC	Auto NUC	
1	Disable Alarm <sup>1</sup>	Reserved	Image Live	Image Freeze	DI 2	DI 1	DO 2	DO 1	
2	Atmospheric Temp. Graphic	Reflected Temp. Graphic	Distance Graphic	Emissivity Graphic	Date/Time Graphic	Scale Graphic	Camera Label Graphic	Enable Overlay Graphics	
3	Reserved	Reserved	Reserved	Reserved	Reserved	Measurement Mark Graphic	Lens Graphic	Relative Humidity Graphic	
4	Alarm 8	Alarm 7	Alarm 6	Alarm 5	Alarm 4	Alarm 3	Alarm 2	Alarm 1	
5	Set Configuration Preset (RESERVED FOR FUTURE USE)								
6	Reserved	Reserved	Reserved	Reserved	Reserved	Reserved	Reserved	Reserved	Reserved
7	Reserved	Reserved	Reserved	Reserved	Reserved	Reserved	Reserved	Reserved	Reserved

<sup>1</sup> This alarm is the BATCH alarm. It has the ability to enable or disable all the other 8 alarms.

**Heartbeat and Configuration Instances**

**Input Only Heartbeat (Instance 128 (0x80))**

This instance allows clients to monitor input data without providing output data.

**Listen Only Heartbeat (Instance 129 (0x81))**

This instance allows clients to monitor input data without providing output data. To utilize this connection type, an owning connection must exist from a second client and the configuration of the connection must match exactly.

**Configuration Instance (Unused)**

Since some PLC’s require a configuration instance, enter 1.

Table 2-5 Assembly Object’s common services

Service code	Implemented for		Service name
	Class level	Instance level	
0E <sub>Hex</sub>	Yes	Yes	Get_Attribute_Single
10 <sub>Hex</sub>	No	Yes	Set_Attribute_Single

**1.4 Connection Manager Object (06<sub>HEX</sub>- 0 Instances)**

\*\*\*No supported services or attributes\*\*\*

**1.5 PCCC Object (67<sub>HEX</sub> - 1 Instance)**

The PCCC Object has no class or instance attributes. The following tables contain common services information and PCCC Mapping parameters for the PCCC Object.

**Table 1-6 PCCC Object's common services**

Service code	Implemented for		Service name
	Class level	Instance level	
4B <sub>Hex</sub> *	No	Yes	Execute PCCC Request

\* EtherNet/IP devices use the "Execute PCCC Request" service code (4B<sub>Hex</sub>) to communicate with older controllers like the PLC5E and the SLC 5/05.

**Table 1-7 PCCC Object (67<sub>HEX</sub>) Output Integers-- Read/Write**

PCCC Register	Data											Description													
	Bit 7	Bit 6	Bit 5	Bit 4	Bit 3	Bit 2	Bit 1	Bit 0	Bit 15	Bit 14	Bit 13		Bit 12	Bit 11	Bit 10	Bit 9	Bit 8	Bit 7	Bit 6	Bit 5	Bit 4	Bit 3	Bit 2	Bit 1	Bit 0
N10:0	Reserved	Force Image One Shot	Save Image	One Time Image Auto Adjust	Auto Focus Fast	Auto Focus Full	Force NUC	Auto NUC	Reserved	Image Live	Image Freeze	Reserved	Reserved	DO 1	Reserved	DO 2	Reserved	DO 1							
	Reserved	Reserved	Distance Graphic	Emissivity Graphic	Date/Time Graphic	Scale Graphic	Camera Label Graphic	Enable Overlay Graphics	Reserved	Reflected Temp. Graphic	Reserved	Reserved	Reserved	Reserved	Reserved	Reserved	Reserved	DO 1	Relative Humidity Graphic						
	Reserved	Reserved	Reserved	Reserved	Reserved	Reserved	Reserved	Reserved	Reserved	Reserved	Reserved	Reserved	Reserved	Reserved	Reserved	Reserved	Reserved	Reserved	Reserved	Reserved	Reserved	Reserved	Reserved	Reserved	Reserved
N10:1	Reserved	Reserved	Distance Graphic	Emissivity Graphic	Date/Time Graphic	Scale Graphic	Camera Label Graphic	Enable Overlay Graphics	Reserved	Reflected Temp. Graphic	Reserved	Reserved	Reserved	Reserved	Reserved	Reserved	Reserved	Reserved	Reserved	Reserved	Reserved	Reserved	Reserved	Reserved	Reserved
	Reserved	Reserved	Distance Graphic	Emissivity Graphic	Date/Time Graphic	Scale Graphic	Camera Label Graphic	Enable Overlay Graphics	Reserved	Reflected Temp. Graphic	Reserved	Reserved	Reserved	Reserved	Reserved	Reserved	Reserved	Reserved	Reserved	Reserved	Reserved	Reserved	Reserved	Reserved	Reserved
	Reserved	Reserved	Distance Graphic	Emissivity Graphic	Date/Time Graphic	Scale Graphic	Camera Label Graphic	Enable Overlay Graphics	Reserved	Reflected Temp. Graphic	Reserved	Reserved	Reserved	Reserved	Reserved	Reserved	Reserved	Reserved	Reserved	Reserved	Reserved	Reserved	Reserved	Reserved	Reserved
N10:2	Reserved	Reserved	Distance Graphic	Emissivity Graphic	Date/Time Graphic	Scale Graphic	Camera Label Graphic	Enable Overlay Graphics	Reserved	Reflected Temp. Graphic	Reserved	Reserved	Reserved	Reserved	Reserved	Reserved	Reserved	Reserved	Reserved	Reserved	Reserved	Reserved	Reserved	Reserved	Reserved
	Reserved	Reserved	Distance Graphic	Emissivity Graphic	Date/Time Graphic	Scale Graphic	Camera Label Graphic	Enable Overlay Graphics	Reserved	Reflected Temp. Graphic	Reserved	Reserved	Reserved	Reserved	Reserved	Reserved	Reserved	Reserved	Reserved	Reserved	Reserved	Reserved	Reserved	Reserved	Reserved
	Reserved	Reserved	Distance Graphic	Emissivity Graphic	Date/Time Graphic	Scale Graphic	Camera Label Graphic	Enable Overlay Graphics	Reserved	Reflected Temp. Graphic	Reserved	Reserved	Reserved	Reserved	Reserved	Reserved	Reserved	Reserved	Reserved	Reserved	Reserved	Reserved	Reserved	Reserved	Reserved
N10:3	Reserved	Reserved	Distance Graphic	Emissivity Graphic	Date/Time Graphic	Scale Graphic	Camera Label Graphic	Enable Overlay Graphics	Reserved	Reflected Temp. Graphic	Reserved	Reserved	Reserved	Reserved	Reserved	Reserved	Reserved	Reserved	Reserved	Reserved	Reserved	Reserved	Reserved	Reserved	Reserved
	Reserved	Reserved	Distance Graphic	Emissivity Graphic	Date/Time Graphic	Scale Graphic	Camera Label Graphic	Enable Overlay Graphics	Reserved	Reflected Temp. Graphic	Reserved	Reserved	Reserved	Reserved	Reserved	Reserved	Reserved	Reserved	Reserved	Reserved	Reserved	Reserved	Reserved	Reserved	Reserved
	Reserved	Reserved	Distance Graphic	Emissivity Graphic	Date/Time Graphic	Scale Graphic	Camera Label Graphic	Enable Overlay Graphics	Reserved	Reflected Temp. Graphic	Reserved	Reserved	Reserved	Reserved	Reserved	Reserved	Reserved	Reserved	Reserved	Reserved	Reserved	Reserved	Reserved	Reserved	Reserved



Table 1-8 PCCC Object (67<sub>HEX</sub>) Input Integers Little Endian– Read Only

PCCC Register	Data										Description
N11:0	Bit 7	Bit 6	Bit 5	Bit 4	Bit 3	Bit 2	Bit 1	Bit 0			
	Reserved	Force Image One Shot	Save Image	One Time Image Auto Adjust	Auto Focus Fast	Auto Focus Full	Force NUC	Auto NUC			
	Bit 15	Bit 14	Bit 13	Bit 12	Bit 11	Bit 10	Bit 9	Bit 8			
N11:1	Disable Alarm <sup>1</sup>	Reserved	Image Live	Image Freeze	DI 2	DI 1	DO 2	DO 1			
	Bit 7	Bit 6	Bit 5	Bit 4	Bit 3	Bit 2	Bit 1	Bit 0			
	Atmospheric Temp. Graphic	Reflected Temp. Graphic	Distance Graphic	Emissivity Graphic	Date/Time Graphic	Scale Graphic	Camera Label Graphic	Enable Overlay Graphics			
N11:2	Bit 15	Bit 14	Bit 13	Bit 12	Bit 11	Bit 10	Bit 9	Bit 8			
	Reserved	Reserved	Reserved	Reserved	Reserved	Measurement Mark Graphic	Lens Graphic	Relative Humidity Graphic			
	Bit 7	Bit 6	Bit 5	Bit 4	Bit 3	Bit 2	Bit 1	Bit 0			
N11:3	Alarm 8	Alarm 7	Alarm 6	Alarm 5	Alarm 4	Alarm 3	Alarm 2	Alarm 1			
	Bit 15	Bit 14	Bit 13	Bit 12	Bit 11	Bit 10	Bit 9	Bit 8			
	Set Configuration Preset (RESERVED FOR FUTURE USE)										
N11:4-5	Bit 7	Bit 6	Bit 5	Bit 4	Bit 3	Bit 2	Bit 1	Bit 0			
	Reserved	Reserved	Reserved	Reserved	Reserved	Reserved	Reserved	Reserved			
	Bit 15	Bit 14	Bit 13	Bit 12	Bit 11	Bit 10	Bit 9	Bit 8			
N11:6-7	Reserved	Reserved	Reserved	Reserved	Reserved	Reserved	Reserved	Reserved			
	Delta Temperature 1										
	Delta Temperature 2										
N11:8-9	Delta Temperature 3										
	Delta Temperature 4										
	Delta Temperature 5										
N11:10-11	Delta Temperature 6										
	Internal Camera Temperature										
	Spot 1 Temperature										
N11:12-13	Box 1 Min Temperature										
	Box 1 Max Temperature										
	Box 1 Average Temperature										
N11:14-15	Reserved										
	Reserved										
	Reserved										
N11:16-17	Reserved										
	Reserved										
	Reserved										
N11:18-19	Reserved										
	Reserved										
	Reserved										
N11:20-21	Reserved										
	Reserved										
	Reserved										
N11:22-23	Reserved										
	Reserved										
	Reserved										
N11:24-25	Reserved										
	Reserved										
	Reserved										

Input Integers Little-Endian (READ ONLY)

<sup>1</sup> This alarm is the BATCH alarm. It has the ability to enable or disable all the other 8 alarms.

PCCC Register	Data	Description
N11:26	Spot 1 Temperature Valid State	Input Integers Little-Endian (continued)
N11:27	Box 1 Min Temperature Valid State	
N11:28	Box 1 Max Temperature Valid State	
N11:29	Box 1 Avg Temperature Valid State	
N11:30-31	Spot 2 Temperature	
N11:32-33	Box 2 Min Temperature	
N11:34-35	Box 2 Max Temperature	
N11:36-37	Box 2 Average Temperature	
N11:38	Spot 2 Temperature Valid State	
N11:39	Box 2 Min Temperature Valid State	
N11:40	Box 2 Max Temperature Valid State	
N11:41	Box 2 Avg Temperature Valid State	
N11:42-43	Spot 3 Temperature	
N11:44-45	Box 3 Min Temperature	
N11:46-47	Box 3 Max Temperature	
N11:48-49	Box 3 Average Temperature	
N11:50	Spot 3 Temperature Valid State	
N11:51	Box 3 Min Temperature Valid State	
N11:52	Box 3 Max Temperature Valid State	
N11:53	Box 3 Avg Temperature Valid State	
N11:54-55	Spot 4 Temperature	
N11:56-57	Box 4 Min Temperature	
N11:58-59	Box 4 Max Temperature	
N11:60-61	Box 4 Average Temperature	
N11:62	Spot 4 Temperature Valid State	
N11:63	Box 4 Min Temperature Valid State	
N11:64	Box 4 Max Temperature Valid State	
N11:65	Box 4 Avg Temperature Valid State	
N11:66-77	.....Spot 5/ Box 5.....	

PCCC Register	Data	Description
N11:78-89	.....Spot 6/ Box 6.....	Input Integers Little-Endian (continued)
N11:90-101	.....Spot 7/ Box 7.....	
N11:102-113	.....Spot 8/ Box 8.....	
N11:114-125	.....Spot 9/ Box 9.....	
N11:126-137	.....Spot 10/ Box 10.....	
N11:138-149	.....Spot 11/ Box 11.....	
N11:150-161	.....Spot 12/ Box 12.....	
N11:162-173	.....Spot 13/ Box 13.....	
N11:174-185	.....Spot 14/ Box 14.....	
N11:186-197	.....Spot 15/ Box 15.....	
N11:198-209	.....Spot 16/ Box 16.....	
N11:210-221	.....Spot 17/ Box 17.....	
N11:222-233	.....Spot 18/ Box 18.....	
N11:234-245	.....Spot 19/ Box 19.....	
N11:246-257	.....Spot 20/ Box 20.....	

Table 1-9 PCCC Object (67<sub>HEX</sub>) Input Integers Big Endian– Read Only

PCCC Register	Data										Description
N12:0	Bit 7	Bit 6	Bit 5	Bit 4	Bit 3	Bit 2	Bit 1	Bit 0			Input Integers Big-Endian
	Reserved	Force Image One Shot	Save Image	One Time Image Auto Adjust	Auto Focus Fast	Auto Focus Full	Force NUC	Auto NUC			
	Bit 15 Disable Alarm <sup>1</sup>	Bit 14 Reserved	Bit 13 Image Live	Bit 12 Image Freeze	Bit 11 DI 2	Bit 10 DI 1	Bit 9 DO 2	Bit 8 DO 1			

<sup>1</sup> This alarm is the BATCH alarm. It has the ability to enable or disable all the other 8 alarms.

PCCC Register	Data											Description				
N12:1	Bit 7	Bit 6	Bit 5	Bit 4	Bit 3	Bit 2	Bit 1	Bit 0	Atmospheric Temp. Graphic	Reflected Temp. Graphic	Distance Graphic	Emissivity Graphic	Date/Time Graphic	Scale Graphic	Camera Label Graphic	Enable Overlay Graphics
	Bit 15	Bit 14	Bit 13	Bit 12	Bit 11	Bit 10	Bit 9	Bit 8	Reserved	Reserved	Reserved	Reserved	Reserved	Measurement Mark Graphic	Lens Graphic	Relative Humidity Graphic
	Bit 7	Bit 6	Bit 5	Bit 4	Bit 3	Bit 2	Bit 1	Bit 0	Alarm 8	Alarm 7	Alarm 6	Alarm 5	Alarm 4	Alarm 3	Alarm 2	Alarm 1
	Bit 15	Bit 14	Bit 13	Bit 12	Bit 11	Bit 10	Bit 9	Bit 8	Reserved	Reserved	Reserved	Reserved	Reserved	Reserved	Reserved	Reserved
N12:2	Set Configuration Preset (RESERVED FOR FUTURE USE)															
N12:3	Bit 7	Bit 6	Bit 5	Bit 4	Bit 3	Bit 2	Bit 1	Bit 0	Reserved	Reserved	Reserved	Reserved	Reserved	Reserved	Reserved	Reserved
N12:4-5	Delta Temperature 1															
N12:6-7	Delta Temperature 2															
N12:8-9	Delta Temperature 3															
N12:10-11	Delta Temperature 4															
N12:12-13	Delta Temperature 5															
N12:14-15	Delta Temperature 6															
N12:16-17	Internal Camera Temperature															
N12:18-19	Spot 1 Temperature															
N12:20-21	Box 1 Min Temperature															
N12:22-23	Box 1 Max Temperature															
N12:24-25	Box 1 Average Temperature															
N12:26	Spot 1 Temperature Valid State															
N12:27	Box 1 Min Temperature Valid State															
N12:28	Box 1 Max Temperature Valid State															
N12:29	Box 1 Avg Temperature Valid State															
N12:30-31	Spot 2 Temperature															
N12:32-33	Box 2 Min Temperature															
N12:34-35	Box 2 Max Temperature															
N12:36-37	Box 2 Average Temperature															

Input  
Integers  
Big-Endian  
(continued)

PCCC Register	Data	Description
N12:38	Spot 2 Temperature Valid State	Input Integers Big-Endian (continued)
N12:39	Box 2 Min Temperature Valid State	
N12:40	Box 2 Max Temperature Valid State	
N12:41	Box 2 Avg Temperature Valid State	
N12:42-43	Spot 3 Temperature	
N12:44-45	Box 3 Min Temperature	
N12:46-47	Box 3 Max Temperature	
N12:48-49	Box 3 Average Temperature	
N12:50	Spot 3 Temperature Valid State	
N12:51	Box 3 Min Temperature Valid State	
N12:52	Box 3 Max Temperature Valid State	
N12:53	Box 3 Avg Temperature Valid State	
N12:54-55	Spot 4 Temperature	
N12:56-57	Box 4 Min Temperature	
N12:58-59	Box 4 Max Temperature	
N12:60-61	Box 4 Average Temperature	
N12:62	Spot 4 Temperature Valid State	
N12:63	Box 4 Min Temperature Valid State	
N12:64	Box 4 Max Temperature Valid State	
N12:65	Box 4 Avg Temperature Valid State	
N12:66-77	.....Spot 5/Box 5.....	
N12:78-89	.....Spot 6/Box 6.....	
N12:90-101	.....Spot 7/Box 7.....	
N12:102-113	.....Spot 8/Box 8.....	
N12:114-125	.....Spot 9/Box 9.....	
N12:126-137	.....Spot 10/Box 10.....	
N12:138-149	.....Spot 11/Box 11.....	
N12:150-161	.....Spot 12/Box 12.....	
N12:162-173	.....Spot 13/Box 13.....	

<b>PCCC Register</b>	<b>Data</b>	<b>Description</b>
N12:174-185	.....Spot 14/ Box 14.....	Input Integers Big-Endian (continued)
N12:186-197	.....Spot 15/ Box 15.....	
N12:198-209	.....Spot 16/ Box 16.....	
N12:210-221	.....Spot 17/ Box 17.....	
N12:222-233	.....Spot 18/ Box 18.....	
N12:234-245	.....Spot 19/ Box 19.....	
N12:246-257	.....Spot 20/ Box 20.....	

**Table 1-10 PCCC Object (67<sub>HEX</sub>) Input Floats– Read Only**

<b>PCCC Register</b>	<b>Data</b>	<b>Description</b>
F13:0	Delta Temperature 1	Input Floats (READ ONLY)
F13:1	Delta Temperature 2	
F13:2	Delta Temperature 3	
F13:3	Delta Temperature 4	
F13:4	Delta Temperature 5	
F13:5	Delta Temperature 6	
F13:6	Internal Camera Temperature	
F13:7	Spot 1 Temperature	
F13:8	Box 1 Min Temperature	
F13:9	Box 1 Max Temperature	
F13:10	Box 1 Average Temperature	
F13:11	Spot 2 Temperature	
F13:12	Box 2 Min Temperature	
F13:13	Box 2 Max Temperature	
F13:14	Box 2 Average Temperature	
F13:15	Spot 3 Temperature	
F13:16	Box 3 Min Temperature	

PCCC Register	Data	Description
F13:17	Box 3 Max Temperature	Input Floats (continued)
F13:18	Box 3 Average Temperature	
F13:19	Spot 4 Temperature	
F13:20	Box 4 Min Temperature	
F13:21	Box 4 Max Temperature	
F13:22	Box 4 Average Temperature	
F13:23-26	.....Spot 5/ Box 5.....	
F13:27-30	.....Spot 6/ Box 6.....	
F13:31-34	.....Spot 7/ Box 7.....	
F13:35-38	.....Spot 8/ Box 8.....	
F13:39-42	.....Spot 9/ Box 9.....	
F13:43-46	.....Spot 10/ Box 10.....	
F13:47-50	.....Spot 11/ Box 11.....	
F13:51-54	.....Spot 12/ Box 12.....	
F13:55-58	.....Spot 13/ Box 13.....	
F13:59-62	.....Spot 14/ Box 14.....	
F13:63-66	.....Spot 15/ Box 15.....	
F13:67-70	.....Spot 16/ Box 16.....	
F13:71-74	.....Spot 17/ Box 17.....	
F13:75-78	.....Spot 18/ Box 18.....	
F13:79-82	.....Spot 19/ Box 19.....	
F13:83-86	.....Spot 20/ Box 20.....	

**For additional PCCC mappings, refer to Appendix A**





Table 2-12 TCP Object's common services

Service code	Implemented for		Service name
	Class level	Instance level	
0E <sub>Hex</sub>	Yes	Yes	Get_Attribute_Single
10 <sub>Hex</sub>	No	Yes	Set_Attribute_Single

### 1.7 Ethernet Link Object (F6<sub>HEX</sub> - 1 Instance)

The following tables contain the attribute and common services information for the Ethernet Link Object.

Table 2-13 Ethernet Link Object (F6<sub>HEX</sub> - 1 Instance)

Instance	Attribute ID	Name	Data Type	Data Value	Access Rule
Class (Instance 0)	1	Revision	UINT	3	Get
Instance 1	1	Interface speed*	UDINT	100	Get
	2	Interface flags*	DWORD	3	Get
	3	Physical address	USINT Array (6)	0	Get

\* For more details on these attributes, see *Volume 2: EtherNet/IP Adaptation of CIP*, Section 5-4.2 from ODVA.

Table 2-14 Ethernet Link Object's common services

Service code	Implemented for		Service name
	Class level	Instance level	
0E <sub>Hex</sub>	Yes	Yes	Get_Attribute_Single

**1.8 System Command Object (64<sub>HEX</sub>- 1 Instance)**

**1.8.1 Class and Instance Attributes**

The following tables contain the attribute and common services information for System Command Object.

Instance	Attribute ID	Name	Data Type	Data Value	Access Rule	Comment
Class (Instance 0)	1	Revision	UINT	1	Get	
Instance 1	1	Camera Distance Units	SHORT STRING32	“feet”, “meter”	Get/Set	
	2	Camera Temperature Units	SHORT STRING32	“C”: Celsius “F”: Fahrenheit	Get/Set	
	3	Current Preset Profile	USINT		Get/Set	For now will always return Error Code

**1.8.2 Class and Instance Services**

Service code	Implemented for		Service name
	Class level	Instance level	
0E <sub>Hex</sub>	Yes	Yes	Get_Attribute_Single
10 <sub>Hex</sub>	No	Yes	Set_Attribute_Single

**1.8.3 Description of Instance Attributes**

**1.8.3-1 Camera Distance Units**

This attribute sets the display units for measuring distance within IR Monitor ONLY. Acceptable unit values are “Feet” and “Meter”.

**1.8.3-2 Camera Temperature Units**

This attribute sets the display units for measuring temperature within IR Monitor ONLY. Acceptable unit values are “C” for Celsius and “F” for Fahrenheit.

**1.8.3-3 Current Preset Profile**

The attribute is reserved for future expansion and has no effect on the camera.

**1.9 Camera Control Command Object (65<sub>HEX</sub>- 1 Instance)**

**1.9.1 Class and Instance Attributes**

The following tables contain the attribute and common services information for Camera Control Command Object.

Instance	Attribute ID	Name	Data Type	Data Value	Access Rule	Comment
Class (Instance 0)	1	Revision	UINT	1	Get	
Instance 1						
	1	Auto NUC	BOOL	0: Disable 1: Enable	Get/Set	
	2	Force NUC *	BOOL	0: Do Nothing 1: Execute	Get/Set	
	3	Full Auto Focus *	BOOL	0: Do Nothing 1: Full Auto Focus	Get/Set	N/A for FLIR Ax8
	4	Fast Auto Focus *	BOOL	0: Do Nothing 1: Fast Auto Focus	Get/Set	N/A for FLIR Ax8
	5	Focus Control Speed	USINT	0-100	Get/Set	N/A for FLIR Ax8
	6	Focus Control	USINT	0: Do Nothing 1: Near (-) 2: Far (+)	Get/Set	N/A for FLIR Ax8
	7	Focus Position	DINT	0-max	Get/Set	N/A for FLIR Ax8
	8	Digital Zoom	REAL	1.0-8.0	Get/Set	
	9	Enable Overlay Graphics	BOOL	0: Disable 1: Enable	Get/Set	
	10	Overlay Graphic Camera Label	BOOL	0: Off 1: On	Get/Set	
	11	Overlay Graphic Scale	BOOL	0: Off 1: On	Get/Set	

Instance	Attribute ID	Name	Data Type	Data Value	Access Rule	Comment
	12	Overlay Graphic Date/Time	BOOL	0: Off 1: On	Get/Set	N/A for FLIR Ax8
	13	Overlay Graphic Emissivity	BOOL	0: Off 1: On	Get/Set	N/A for FLIR Ax8
	14	Overlay Graphic Distance	BOOL	0: Off 1: On	Get/Set	N/A for FLIR Ax8
	15	Overlay Graphic Reflected Temp.	BOOL	0: Off 1: On	Get/Set	N/A for FLIR Ax8
	16	Overlay Graphic Atmospheric Temp.	BOOL	0: Off 1: On	Get/Set	N/A for FLIR Ax8
	17	Overlay Graphic Relative Humidity	BOOL	0: Off 1: On	Get/Set	N/A for FLIR Ax8
	18	Overlay Graphic Lens	BOOL	0: Off 1: On	Get/Set	N/A for FLIR Ax8
	19	Overlay Graphic Measurement Mask	BOOL	0: Off 1: On	Get/Set	N/A for FLIR Ax8

\*Momentary Toggle- Read will always return 0

1.9.2 Class and Instance Services

Service code	Implemented for		Service name
	Class level	Instance level	
0E <sub>Hex</sub>	Yes	Yes	Get_Attribute_Single
10 <sub>Hex</sub>	No	Yes	Set_Attribute_Single

### 1.9.3

#### **Description of Instance Attributes**

##### **1.9.3-1 Auto NUC**

This attribute either enables or disables the Auto NUC functionality in the camera. NUC stands for non-uniformity correction. If this attribute is enabled, the camera will auto-correct whenever necessary. If disabled, the camera will rely on the user to force an Auto NUC when needed, see 1.9.3-2.

##### **1.9.3-2 Force NUC**

This attribute forces a NUC to execute. Since this is a momentary toggle, the read will always return 0.

##### **1.9.3-3 Full Auto Focus**

This attribute forces a coarse autofocus to execute using the entire focus range. Since this is a momentary toggle, the read will always return 0.

##### **1.9.3-4 Fast Auto Focus**

This attribute forces a fine autofocus to execute using the nearby focus range. Since this is a momentary toggle, the read will always return 0.

##### **1.9.3-5 Focus Control Speed**

This attribute sets the step value for a focus. The acceptable range for this attribute is 0-100. A value of 0 indicates no change, 1 is the smallest focus step change possible, and 100 is the largest focus step change possible. Once the step change is set here, the Focus command is executed by Attribute 6, see 1.9.3-6 for more details.

##### **1.9.3-6 Focus Control**

This attribute depends on the values of Attribute 5. If a 0 is written, no change will occur. If a 1 is written, the refocus will move towards near focus for the amount given in Attribute 5. If a 2 is written, the refocus will move towards far focus for the amount given in Attribute 5. All other the values are not accepted.

##### **1.9.3-7 Focus Position**

This attribute forces the camera to refocus to the absolute position provided. The range of values depends on the camera.

##### **1.9.3-8 Digital Zoom**

This attribute controls the digital zoom factor in the camera. The acceptable range of values is 1.0-8.0, where 1.0 is the lowest zoom factor and 8.0 is the highest zoom factor.

##### **1.9.3-9 Enable Overlay Graphics**

This attribute either shows or hides the enabled overlay graphic options (Attributes 10-19) in IR Monitor. If this is disabled, it will also hide any spot or box temperature information as well.

##### **1.9.3-10 Overlay Graphic Camera Label**

This attribute either enables or disables the overlay camera label graphic in IR Monitor.

##### **1.9.3-11 Overlay Graphic Scale**

This attribute either enables or disables the overlay camera scale graphic in IR Monitor.

**1.9.3-12 Overlay Graphic Date/Time**

This attribute either enables or disables the overlay camera date and time graphic in IR Monitor.

**1.9.3-13 Overlay Graphic Emissivity**

This attribute either enables or disables the overlay camera emissivity graphic in IR Monitor.

**1.9.3-14 Overlay Graphic Distance**

This attribute either enables or disables the overlay camera distance graphic in IR Monitor.

**1.9.3-15 Overlay Graphic Reflected Temp.**

This attribute either enables or disables the overlay camera reflected temperature graphic in IR Monitor.

**1.9.3-16 Overlay Graphic Atmospheric Temp.**

This attribute either enables or disables the overlay camera atmospheric temperature graphic in IR Monitor.

**1.9.3-17 Overlay Graphic Relative Humidity**

This attribute either enables or disables the overlay camera relative humidity graphic in IR Monitor.

**1.9.3-18 Overlay Graphic Lens**

This attribute either enables or disables the overlay camera lens graphic in IR Monitor.

**1.9.3-19 Overlay Graphic Measurement Mask**

This attribute either enables or disables the overlay camera measurement mask graphic in IR Monitor.

**1.10 Temperature Control Object (66<sub>HEX-n</sub> Instances)**

**1.10.1 Class and Instance Attributes**

The following tables contain the attribute and common services information for the Temperature Control Object.

Instance	Attribute ID	Name	Data Type	Data Value	Access Rule	Comment
Class (Instance 0)	1	Revision	UINT	1	Get	
	2	Max Instance	UINT		Get	
	100	Lens name	SHORT STRING32		Get	
	101	Write Lens ID to ".le"	SHORT STRING32		Get/Set	
	102	Write "ds" to ".image.ccase.query.ds"	SHORT STRING32		Get/Set	
	103	Write "ap" to ".image.ccase.query.ap"	SHORT STRING32		Get/Set	
	104	Write "f" to ".image.ccase.query.f"	SHORT STRING32		Get/Set	
	105	Case Query	SHORT STRING32		Get	
	106	Current Temp. Range Case	SHORT STRING32		Get/Set	
	107	Change Temperature Case *	BOOL	0: Do Nothing 1: Execute	Get/Set	
Instance 1-n						
	1	Current Upper Limit Temp.	REAL	Kelvin	Get	
	2	Current Lower Limit Temp.	REAL	Kelvin	Get	
	3	Case Enabled	BOOL	0: No 1: Yes	Get	

\*Momentary Toggle- Read will always return 0

**1.10.2 Class and Instance Services**

Service code	Implemented for		Service name
	Class level	Instance level	
0E <sub>Hex</sub>	Yes	Yes	Get_Attribute_Single
10 <sub>Hex</sub>	Yes	No	Set_Attribute_Single

**1.10.3 Description of Class Attributes**

**In order for the lens query, get current lens case, or change current lens case to work properly, follow these steps:**

- Read Class Attribute 100
  - Note:** The string from the Class 100 Attribute consists of a resource path and the Lens id. The path should not be a part of the Lens id when used in Class Attribute 101. The Lens id is the suffix string from the last dot, ie: ".node1.node2.<LensID>"
- Write the lens id received from Class Attribute 100 to Class Attribute 101
- Write the string "ds" to Class Attribute 102
- Write the string "ap" to Class Attribute 103
- Write the string "ff" to Class Attribute 104
- Read Class Attribute 105 to query the lens cases
- To change the current lens, write the desired lens case to Class Attribute 106 and then write a 1 to Class Attribute 107 to execute the change
- To read the current lens case, read Class Attribute 106

**1.10.3-1 Max Instance**

This attribute will show the number of temperature cases that are configured in the camera. This value will only be calculated after Attribute 105 is called for the first time (see 1.10.3-7 for more information), otherwise the value will stay at 0.

**1.10.3-2 Lens Name**

This attribute will output the name of the lens configured in the camera in a string.

**1.10.3-3 Write Lens Id to ".le"**

Take the response from Attribute 100 (Lens Name), and write this string into this attribute. For example, if the Lens Name returned "leE" or 0x6C 0x65 0x45, then you must write 0x03 0x6C 0x65 0x45 into this attribute (with the length of the string as the first byte).



**1.10.3-4 Write “ds” to “.image.ccase.query.ds”**

Write the string “ds” into this attribute. Write 0x02 0x64 0x73 (the length of the string is in the first byte).

**1.10.3-5 Write “ap” to “.image.ccase.query.ap”**

Write the string “ap” into this attribute. Write 0x02 0x61 0x70 (the length of the string is in the first byte).

**1.10.3-6 Write “ff” to “.image.ccase.query.ff”**

Write the string “ff” into this attribute. Write 0x02 0x66 0x69 (the length of the string is in the first byte).

**1.10.3-7 Case Query**

This attribute will display the lens cases currently configured in the camera. For example, a response of 0x04 0x20 0x30 0x20 0x31 means that cases 0 and 1 have been found.

**1.10.3-8 Current Temperature Range Case**

This attribute will display the current temperature range case selected in the camera. To change the temperature range case, you must first write the new temperature case in this attribute and then execute Attribute 107 (see 1.10.3-9).

**1.10.3-9 Change Temperature Case**

If a 0 is written, no change will occur. If a 1 is written, the current temperature range case will be overwritten by the case assigned to Attribute 106 (see 1.10.3-8). Since this is a momentary toggle, the read will always return 0.

**1.10.4 Description of Instance Attributes**

Instance 1 corresponds to Case 0, Instance 2 corresponds to Case 1, etc....

**1.10.4-1 Current Upper Limit Temperature**

This attribute returns the upper limit temperature for a particular lens case in Kelvin.

**1.10.4-2 Current Lower Limit Temperature**

This attribute returns the lower limit temperature for a particular lens case in Kelvin.

**1.10.4-3 Case Enabled**

This attribute returns a value of 1 if this lens case has been calibrated for the camera, and returns a value of 0 if this lens case does not exist in the camera.

**1.11 Image Control Commands Object (67<sub>HEX</sub>- 1 Instance)**

**1.11.1 Class and Instance Attributes**

The following tables contain the attribute and common services information for Image Control Commands

Instance	Attribute ID	Name	Data Type	Data Value	Access Rule	Comment
Class (Instance 0)	1	Revision	UINT	1	Get	
Instance 1						
	1	Palette	SHORT STRING32	“bw.pal” “iron.pal” “rainbox.pal”	Get/Set	
	2	Palette Invert	BOOL	0: Normal 1: Reverse	Get/Set	
	3	Quality	USINT	0: High (7) 1: Normal (20) 2: Low (31)	Get/Set	
	4	Image Automatic Adjust	SHORT STRING32	“Auto”, “Manual”	Get/Set	
	5	Scale Min	REAL	Kelvin	Get/Set	
	6	Scale Max	REAL	Kelvin	Get/Set	
	7	Span	REAL	Kelvin	Get/Set	
	8	Level	REAL	Kelvin	Get/Set	
	9	One Time Image Auto Adjust *	BOOL	0: Do Nothing 1: Execute	Get/Set	
	10	Image Adjust Method	SHORT STRING32	“Linear”, “Histogram”	Get/Set	
	11	Image Freeze	BOOL	0: Off 1: On	Get/Set	
	12	Image Live	BOOL	0: Off 1: On	Get/Set	

Instance	Attribute ID	Name	Data Type	Data Value	Access Rule	Comment
	13	Image State	SHORT STRING32	“LIVE”, “FREEZE”	Get	
	14	Image Measure Mode	BOOL	0:Normal 1:High Prio One Shot	Get/Set	
	15	Image Measurement One Shot *	BOOL	0: Do Nothing 1:Execute	Get/Set	

\*Momentary Toggle- Read will always return 0

**1.11.2 Class and Instance Services**

Service code	Implemented for		Service name
	Class level	Instance level	
0E <sub>Hex</sub>	Yes	Yes	Get_Attribute_Single
10 <sub>Hex</sub>	No	Yes	Set_Attribute_Single

**1.11.3 Description of Instance Attributes**

**1.11.3-1 Palette**

This attribute sets the current color palette setting for the camera. The default palette choices set up in the camera are “bw.pal”, “iron.pal”, and “rainbow.pal”.

**1.11.3-2 Palette Invert**

This attribute either enables or disables the invert palette option in the camera. A value of 1 indicates that the palette colors will be inverted.

**1.11.3-3 Quality**

This attribute controls the quality of the image resolution in IR Monitor. A value of 0 indicates a high video quality. A value of 1 indicates a normal video quality. A value of 2 indicates a low video quality.

**1.11.3-4 Image Automatic Adjust**

This attribute controls whether the overall scale temperature range will be automatically updated around the temperatures being read, or the range will only be updated if the user has to send a manual request in Attribute 9 to update.

**1.11.3-5 Scale Min**

This attribute sets the value of the minimum temperature scale setting in Kelvin. This setting is used in conjunction with Attribute 6 and is only effective if Attribute 4 is set to Manual.

**1.11.3-6 Scale Max**

This attribute sets the value of the maximum temperature scale setting in Kelvin. This setting is used in conjunction with Attribute 5 and is only effective if Attribute 4 is set to Manual.

**1.11.3-7 Span**

This attribute sets the value of the temperature scale span setting in Kelvin. This setting is used in conjunction with Attribute 8 and is only effective if Attribute 4 is set to Manual.

**1.11.3-8 Level**

This attribute sets the center of the temperature scale span setting in Kelvin. This setting is used in conjunction with Attribute 7 and is only effective if Attribute 4 is set to Manual.

**1.11.3-9 One Time Image Auto Adjust**

This attribute forces the scale temperature ranges to be updated. This setting is only effective if Attribute 4 is set to Manual.

**1.11.3-10 Image Adjust Method**

This attribute sets the method used to distribute the image colors. Acceptable values are “Linear” and “Histogram”. This setting is only effective if Attribute 4 is set to Manual.

**1.11.3-11 Image Freeze**

This attribute sets the image stream to freeze or stop continuous streaming.

**1.11.3-12 Image Live**

This attribute sets the image stream to start continuous streaming.

**1.11.3-13 Image State**

This attribute displays whether the image stream state is set to “Freeze” or “Live”.

**1.11.3-14 Image Measure Mode**

This attribute controls when the temperature values are to be updated. Set to 1 if you want to control when the temperatures are updated only when Attribute 15 is executed. Set to 0 if temperatures are to be read and updated continuously.

**1.11.3-15 Image Measurement One Shot**

This attribute executes a command to update the temperature value readings. This setting is only effective if Attribute 14 is set to 1.

**1.12 Isotherm Control Commands Object (68<sub>HEX</sub>- 1 Instance)**

**1.12.1 Class and Instance Attributes**

The following tables contain the attribute and common services information for Isotherm Control Commands

Instance	Attribute ID	Name	Data Type	Data Value	Access Rule	Comment
Class (Instance 0)	1	Revision	UINT	1	Get	
	2	Max Instance	UINT		Get	
Instance 1	1	Isotherm Enable	BOOL	0: Off 1: On	Get/Set	
	2	Isotherm Type	SHORT STRING32	“Above” “Below”	Get/Set	
	3	Isotherm Level	REAL	Kelvin	Get/Set	
	4	Isotherm Color	SHORT STRING32	“palette1” “palette2” “red” “green” “blue” “yellow” “cyan” “magenta” “gray”	Get/Set	

**1.12.2 Class and Instance Services**

Service code	Implemented for		Service name
	Class level	Instance level	
0E <sub>Hex</sub>	Yes	Yes	Get_Attribute_Single
10 <sub>Hex</sub>	No	Yes	Set_Attribute_Single

**1.12.3 Description of Class Attributes**

Currently the camera is only enabled for one isotherm. In the future, there may be future instances for additional isotherms.

**1.12.3-1 Max Instance**

This attribute indicates how many isotherms are enabled in the camera and can be used.

**1.12.4 Description of Instance Attributes**

Currently the camera is only enabled for one isotherm. In the future, there may be future instances for additional isotherms.

**1.12.4.1 Isotherm Enable**

This attribute enables the isotherm control.

**1.12.4.2 Isotherm Type**

This attribute sets the type of the isotherm control. As of now, the acceptable values are “Below” and “Above”.

**1.12.4.3 Isotherm Level**

This attribute sets the value of the isotherm low temperature limit in Kelvin.

**1.12.4.4 Isotherm Color**

This attribute sets the color of the isotherm. Acceptable values are “palette1”, “palette2”, “red”, “green”, “blue”, “yellow”, “cyan”, “magenta”, and “gray”.

**1.13 Image File Storage Object (69<sub>HEX</sub>- 1 Instance)**

**1.13.1 Class and Instance Attributes**

The following tables contain the attribute and common services information for Image File Storage.

Instance	Attribute ID	Name	Data Type	Data Value	Access Rule	Comment
Class (Instance 0)	1	Revision	UINT	1	Get	
Instance 1	1	Store Image to Camera Memory *	BOOL	0: Do Nothing 1: Execute	Get/Set	Ax8: Saves images to directory /FLIR/images

\*Momentary Toggle- Read will always return 0

**1.13.2 Class and Instance Services**

Service code	Implemented for		Service name
	Class level	Instance level	
0E <sub>Hex</sub>	Yes	Yes	Get_Attribute_Single
10 <sub>Hex</sub>	No	Yes	Set_Attribute_Single

**1.13.3 Description of Instance Attributes**

**1.13.3-1 Store Image to Camera Memory**

The image will be stored under the \Temp\images\ directory in the FLIR A310 camera and under the /FLIR/images/ directory for FLIR Ax8. The image file name will be automatically created and is made up of the date and time to ensure a unique name with each image store. Since this is a momentary toggle, the read will always return 0. When power is cycled to the camera, the images in this folder will be deleted (A310). You may copy these files out of the camera by using ftp (A310) or sftp (Ax8).

**1.14 Alarm Settings Object (6A<sub>HEX</sub>- 9 Instances)**

**1.14.1 Class and Instance Attributes**

The following tables contain the attribute and common services information for Alarm Settings

Instance	Attribute ID	Name	Data Type	Data Value	Access Rule	Comment
Class (Instance 0)	1	Revision	UINT	1	Get	
	2	Max Instance	UINT		Get	
Instance 1 - 8	1	Alarm Status	BOOL	0: Off 1: On	Get	
Instance 9	1	Alarm Status	BOOL	0: Off 1: On	Get	

**1.14.2 Class and Instance Services**

Service code	Implemented for		Service name
	Class level	Instance level	
0E <sub>Hex</sub>	Yes	Yes	Get_Attribute_Single

**1.14.3 Description of Class Attributes**

Currently the camera is enabled for nine alarms. In the future, there may be more.

**1.14.3-1 Max Instance**

This attribute indicates how many alarms are enabled in the camera and can be used.

**1.14.4 Description of Instance Attributes**



Each instance corresponds to a different Alarm within the camera. Instance 1 is Alarm 1, Instance 2 is Alarm 2, etc.... Instance 9 is the Batch Alarm. The Batch Alarm is used to enable and disable the output of the other active alarms.

**1.14.4-1 Alarm Status**

This attribute displays whether an alarm condition state is active or not.

**1.15 Object Parameters Object (6B<sub>HEX</sub>: 1 Instance)**

**1.15.1 Class and Instance Attributes**

The following tables contain the attribute and common services information for Object Parameters.

Instance	Attribute ID	Name	Data Type	Data Value	Access Rule	Comment
Class (Instance 0)	1	Revision	UINT	1	Get	
Instance 1						
	1	Atmosphere Temperature	REAL	Kelvin	Get/Set	
	2	Emissivity	REAL	0.001-1.0	Get/Set	
	3	Distance	REAL	Meters	Get/Set	
	4	Reflected Temp	REAL	Kelvin	Get/Set	
	5	Relative Humidity	REAL	0.0-1.0	Get/Set	
	6	Window Transmission Rate	REAL	0.001-1.0	Get/Set	
	7	Window Temperature	REAL	Kelvin	Get/Set	

**1.15.2 Class and Instance Services**

Service code	Implemented for		Service name
	Class level	Instance level	
0E <sub>Hex</sub>	Yes	Yes	Get_Attribute_Single
10 <sub>Hex</sub>	No	Yes	Set_Attribute_Single

### **1.15.3 Description of Instance Attributes**

#### **1.15.3-1 Atmosphere Temperature**

This attribute sets the value of atmospheric temperature in Kelvin.

#### **1.15.3-2 Emissivity**

This attribute sets the value of object emissivity. Accepted range is from 0.001 to 1.0.

#### **1.15.3-3 Distance**

This attribute sets the value of the distance to the object in Meters.

#### **1.15.3-4 Reflected Temperature**

This attribute sets the value of the object temperature surroundings in Kelvin.

#### **1.15.3-5 Relative Humidity**

This attribute sets the relative humidity value of the air. Accepted range is from 0.0 to 1.0. A value of 0.30 represents 30% humidity.

#### **1.15.3-6 Window Transmission Rate**

This attribute sets the value of the External Optics transmission. Accepted range is from 0.001 to 1.0. Set to 1.0 if no external optics is present.

#### **1.15.3-7 Window Temperature**

This attribute sets the value of the External Optics temperature in Kelvin. Commonly used for heat shields, close-up lenses, etc.

**1.16 Spot Meter Object (6C<sub>HEX</sub>-20 Instances)**

**1.16.1 Class and Instance Attributes**

The following tables contain the attribute and common services information for Spot Meter.

<b>Instance</b>	<b>Attribute ID</b>	<b>Name</b>	<b>Data Type</b>	<b>Data Value</b>	<b>Access Rule</b>	<b>Comment</b>
Class (Instance 0)	1	Revision	UINT	1	Get	
	2	Max Instance	UINT		Get	
Instance 1 - 20	1	Enable Local Object Parameter Values	BOOL	0: Disabled 1: Enabled	Get/Set	
	2	Reflected Temp.	REAL	Kelvin	Get/Set	
	3	Emissivity	REAL	0.001-1.0	Get/Set	
	4	Distance	REAL	Meters	Get/Set	
	5	Enable Spotmeter	BOOL	0:Disable 1:Enable	Get/Set	
	6	Spotmeter Pixel X-Position	DINT		Get/Set	
	7	Spotmeter Pixel Y-Position	DINT		Get/Set	
	8	Spotmeter Temp.	REAL	Kelvin	Get	

Instance	Attribute ID	Name	Data Type	Data Value	Access Rule	Comment
	9	Spotmeter Temp. State	USINT	0: Undefined(U) 1: Valid (=) 2: Less Than(>) 3: More Than(<) 4: Outside(O) 5: Outside calib.(*) 6: Unstable(~) 7: Compensated with delta correction(d)	Get	

**1.16.2 Class and Instance Services**

Service code	Implemented for		Service name
	Class level	Instance level	
0E <sub>Hex</sub>	Yes	Yes	Get_Attribute_Single
10 <sub>Hex</sub>	No	Yes	Set_Attribute_Single

**1.16.3 Description of Class Attributes**

Currently the camera is enabled for 10 spotmeters (A310) or 5 spotmeters (Ax8).

**1.16.3-1 Max Instance**

This attribute indicates how many spotmeter objects are enabled in the camera and can be used.

**1.16.4 Description of Instance Attributes**

**1.16.4-1 Enable Local Object Parameter Values**

When this attribute is set to enabled (1), that spot uses the Reflected Temperature, Emissivity, and Distance values in Attributes 2, 3 and 4 rather than the global object parameter values in Object 0x6B.

**1.16.4-2 Reflected Temperature**

This attribute sets the value of a particular spot's temperature surroundings in Kelvin. Only used when Attribute 1 is set to 1.

**1.16.4-3 Emissivity**

This attribute sets the value of a particular spot's emissivity. Accepted range is from 0.001 to 1.0. Only used when Attribute 1 is set to 1.

**1.16.4-4 Distance**

This attribute sets the value of the distance to a particular spot object in Meters. Only used when Attribute 1 is set to 1.

**1.16.4-5 Enable Spotmeter**

This attribute either enables (1) or disables (0) a particular spotmeter.

**1.16.4-6 Spotmeter Pixel X-Position**

This attribute sets the value of a particular spot's position on the X-axis. The X-axis is horizontal. As this number increases from 0, the spotmeter will move from left to right.

**1.16.4-7 Spotmeter Pixel Y-Position**

This attribute sets the value of a particular spot's position on the Y-axis. The Y-axis is vertical. As this number increases from 0, the spotmeter will move from top to bottom.

**1.16.4-8 Spotmeter Temperature**

This attribute displays the spotmeter's temperature value in Kelvin.

**1.16.4-9 Spotmeter Temperature State**

This attribute displays the spotmeter's temperature state. The following table shows the different values and their meanings:

Value	Meaning
0	Undefined
1	In the acceptable range
2	Less than the acceptable range
3	More than the acceptable range
4	Outside the acceptable range
5	Outside calibration
6	Unstable temperature
7	Temperature is compensated with delta correction

**1.17 Box Object (6D<sub>HEX</sub>- 20 Instances)**

**1.17.1 Class and Instance Attributes**

The following tables contain the attribute and common services information for Box.

Instance	Attribute ID	Name	Data Type	Data Value	Access Rule	Comment
Class (Instance 0)	1	Revision	UINT	1	Get	
	2	Max Instance	UINT		Get	
Instance 1 - 20	1	Enable Local Object Parameter Values	BOOL	0: Disabled 1: Enabled	Get/Set	
	2	Reflected Temp.	REAL	Kelvin	Get/Set	
	3	Emissivity	REAL	0.001-1.0	Get/Set	
	4	Distance	REAL	Meters	Get/Set	
	5	Enable Box	BOOL	0:Disable 1:Enable	Get/Set	
	6	Box Min Temp.	REAL	Kelvin	Get	

Instance	Attribute ID	Name	Data Type	Data Value	Access Rule	Comment
	7	Box Min Temp. State	USINT	0: Undefined(U) 1: Valid (=) 2: Less Than(>) 3: More Than(<) 4: Outside(O) 5: Outside calib.(*) 6: Unstable(~) 7: Compenstated with delta correction(d)	Get	
	8	Box Max Temp.	REAL	Kelvin	Get	
	9	Box Max Temp. State	USINT	0: Undefined(U) 1: Valid (=) 2: Less Than(>) 3: More Than(<) 4: Outside(O) 5: Outside calib.(*) 6: Unstable(~) 7: Compenstated with delta correction(d)	Get	
	10	Box Avg. Temp.	REAL	Kelvin	Get	



Instance	Attribute ID	Name	Data Type	Data Value	Access Rule	Comment
	11	Box Avg. Temp. State	USINT	0: Undefined(U) 1: Valid (=) 2: Less Than(>) 3: More Than(<) 4: Outside(O) 5: Outside calib.(*) 6: Unstable(~) 7: Compenstated with delta correction(d)	Get	
	12	Box Position X	DINT		Get/Set	
	13	Box Position Y	DINT		Get/Set	
	14	Box Min Temp. Position X	DINT		Get	
	15	Box Min Temp. Position Y	DINT		Get	
	16	Box Max Temp. Position X	DINT		Get	
	17	Box Max Temp. Position Y	DINT		Get	
	18	Box Width	DINT		Get/Set	
	19	Box Height	DINT		Get/Set	
	20	Temp. Display Options	USINT	Bit 0: Display Max Temp. Bit 1: Display Min Temp. Bit 2: Display Avg Temp.	Get/Set	

**1.17.2 Class and Instance Services**

Service code	Implemented for		Service name
	Class level	Instance level	
0E <sub>Hex</sub>	Yes	Yes	Get_Attribute_Single
10 <sub>Hex</sub>	No	Yes	Set_Attribute_Single

**1.17.3 Description of Class Attributes**

Currently the camera is enabled for 10 boxes. In the future, there may be more.

**1.17.3-1 Max Instance**

This attribute indicates how many box objects are enabled in the camera and can be used.

**1.17.4 Description of Instance Attributes**

**1.17.4-1 Enable Local Object Parameter Values**

When this attribute is set to enabled (1), that box uses the Reflected Temperature, Emissivity, and Distance values in Attributes 2, 3 and 4 rather than the global object parameter values in Object 0x6B.

**1.17.4-2 Reflected Temperature**

This attribute sets the value of a particular box's temperature surroundings in Kelvin. Only used when Attribute 1 is set to 1.

**1.17.4-3 Emissivity**

This attribute sets the value of a particular box's emissivity. Accepted range is from 0.001 to 1.0. Only used when Attribute 1 is set to 1.

**1.17.4-4 Distance**

This attribute sets the value of the distance to a particular box object in Meters. Only used when Attribute 1 is set to 1.

**1.17.4-5 Enable Box**

This attribute either enables (1) or disables (0) a particular box.

**1.17.4-6 Box Min Temperature**

This attribute displays the lowest temperature value in a particular box in Kelvin.

**1.17.4-7 Box Min Temperature State**

This attribute displays the temperature state of a box's minimum value. The following table shows the different values and their meanings:

Value	Meaning
0	Undefined
1	In the acceptable range
2	Less than the acceptable range
3	More than the acceptable range
4	Outside the acceptable range
5	Outside calibration
6	Unstable temperature
7	Temperature is compensated with delta correction

**1.17.4-8 Box Max Temperature**

This attribute displays the highest temperature value in a particular box in Kelvin.

**1.17.4-9 Box Max Temperature State**

This attribute displays the temperature state of a box's maximum value. The following table shows the different values and their meanings:

Value	Meaning
0	Undefined
1	In the acceptable range
2	Less than the acceptable range
3	More than the acceptable range
4	Outside the acceptable range
5	Outside calibration
6	Unstable temperature
7	Temperature is compensated with delta correction

**1.17.4-10 Box Average Temperature**

This attribute displays the average temperature value in a particular box in Kelvin.

**1.17.4-11 Box Average Temperature State**

This attribute displays the temperature state of a box's average value. The following table shows the different values and their meanings:

Value	Meaning
0	Undefined
1	In the acceptable range
2	Less than the acceptable range
3	More than the acceptable range
4	Outside the acceptable range
5	Outside calibration
6	Unstable temperature
7	Temperature is compensated with delta correction

**1.17.4-12 Box Position X**

This attribute sets the value of a particular box's position on the X-axis. The X-axis is horizontal. As this number increases from 0, the box will move from left to right.

**1.17.4-13 Box Position Y**

This attribute sets the value of a particular box's position on the Y-axis. The Y-axis is vertical. As this number increases from 0, the box will move from top to bottom.

**1.17.4-14 Box Min Temperature Position X**

This attribute indicates where on the horizontal X-axis the minimum box temperature is located.

**1.17.4-15 Box Min Temperature Position Y**

This attribute indicates where on the vertical Y-axis the minimum box temperature is located.

**1.17.4-16 Box Max Temperature Position X**

This attribute indicates where on the horizontal X-axis the maximum box temperature is located.

**1.17.4-17 Box Max Temperature Position Y**

This attribute indicates where on the vertical Y-axis the maximum box temperature is located.

**1.17.4-18 Box Width**

This attribute sets the value of a particular box's width.

**1.17.4-19 Box Height**

This attribute sets the value of a particular box's height.

**1.17.4-20 Temperature Display Options**

This attribute controls which temperatures will be shown on IR Monitor for a particular box. When a particular bit is set to 1, then that assigned temperature display value will be shown on IR Monitor. Acceptable range is 0 (none shown) - 7 (all shown).

**1.18 Temperature Difference Object (6E<sub>HEX</sub>- 6 Instances)**

**1.18.1 Class and Instance Attributes**

The following tables contain the attribute and common services information for Temperature Difference.

Instance	Attribute ID	Name	Data Type	Data Value	Access Rule	Comment
Class (Instance 0)	1	Revision	UINT	1	Get	
	2	Max Instance	UINT		Get	
	100	Internal Camera Temp.	REAL		Get	
Instance 1-6	1	Enable Temp. Difference	BOOL	0: Disable 1: Enable	Get/Set	
	2	Value of Temp. Difference	REAL	Kelvin	Get	
	3	Difference Temp. Valid State	USINT	0: Undefined(U) 1: Valid (=) 2: Less Than(>) 3: More Than(<=) 4: Outside(O) 5: Outside calib.(*) 6: Unstable(~) 7: Compensated w/ delta correction(d)	Get	

**1.18.2 Class and Instance Services**

Service code	Implemented for		Service name
	Class level	Instance level	
0E <sub>Hex</sub>	Yes	Yes	Get_Attribute_Single
10 <sub>Hex</sub>	No	Yes	Set_Attribute_Single

**1.18.3 Description of Class Attributes**

Currently the camera is enabled for six boxes. In the future, there may be more.

**1.18.3-1 Max Instance**

This attribute indicates how many box objects are enabled in the camera and can be used.

**1.18.3-2 Internal Camera Temperature**

This attribute indicates the internal temperature of the camera in Kelvin.

**1.18.4 Description of Instance Attributes**

**1.18.4-1 Enable Temperature Difference**

This attribute either enables (1) or disables (0) a particular temperature difference instance.

**1.18.4-2 Value of Temperature Difference**

This attribute indicates the temperature difference of a particular temperature difference value set up in the camera in Kelvin.

**1.18.4-3 Difference Temperature Valid State**

This attribute displays the difference temperature's state. The following table shows the different values and their meanings:

Value	Meaning
0	Undefined
1	In the acceptable range
2	Less than the acceptable range
3	More than the acceptable range
4	Outside the acceptable range
5	Outside calibration
6	Unstable temperature
7	Temperature is compensated with delta correction

**1.19 Physical I/O Object (6F<sub>HEX</sub>- 1 Instance)**

**1.19.1 Class and Instance Attributes**

The following tables contain the attribute and common services information for Temperature Difference.

Instance	Attribute ID	Name	Data Type	Data Value	Access Rule	Comment
Class (Instance 0)	1	Revision	UINT	1	Get	
Instance 1						
	1	DI 1	BOOL	0:Off 1:On	Get	
	2	DI 2	BOOL	0:Off 1:On	Get	N/A for FLIR Ax8
	101	DO 1	BOOL	0:Low 1:High	Get/Set	
	102	DO 2	BOOL	0:Low 1:High	Get/Set	N/A for FLIR Ax8

**1.19.2 Class and Instance Services**

Service code	Implemented for		Service name
	Class level	Instance level	
0E <sub>Hex</sub>	Yes	Yes	Get_Attribute_Single
10 <sub>Hex</sub>	No	Yes	Set_Attribute_Single

**1.19.3 Description of Instance Attributes**

**1.19.3-1 DI 1**

This attribute indicates if Digital Input 1 is active (1) or inactive (0).

**1.19.3-2 DI 2**

This attribute indicates if Digital Input 2 is active (1) or inactive (0).

**1.19.3-3 DO 1**

This attribute either sets the Digital Output 1 to an active (1) or inactive (0) state.

**1.19.3-4 DO 2**

This attribute either sets the Digital Output 2 to an active (1) or inactive (0) state.



**1.20 Pass Through Object (70<sub>HEX</sub>- 1 Instance)**

**1.20.1 Class and Instance Attributes**

The following tables contain the attribute and common services information for Temperature Difference.

Instance	Attribute ID	Name	Data Type	Data Value	Access Rule	Comment
Class (Instance 0)	1	Revision	UINT	1	Get	

**1.20.2 Class and Instance Services**

Service code	Implemented for		Service name
	Class level	Instance level	
32 <sub>Hex</sub>	No	Yes	Read_BOOL
33 <sub>Hex</sub>	No	Yes	Write_BOOL
34 <sub>Hex</sub>	No	Yes	Read_INT32
35 <sub>Hex</sub>	No	Yes	Write_INT32
36 <sub>Hex</sub>	No	Yes	Read_DOUBLE
37 <sub>Hex</sub>	No	Yes	Write_DOUBLE
38 <sub>Hex</sub>	No	Yes	Read_ASCII
39 <sub>Hex</sub>	No	Yes	Write_ASCII

**Example using Service Code 0x32:**

Goal: Read Status of Digital Input

Explanation: Data field is filled with the length of the camera variable “.power.states.digin1” followed by the ASCII representation of it.

Service Code	Class	Instance	Attribute	Data
0x32	0x70	0x01		14 2E 70 6F 77 65 72 2E 73 74 61 74 65 73 2E 64 69 67 69 6E 31

**Example using Service Code 0x33:**

Goal: Force an Auto Nuc on the camera

Explanation: Data field is filled with the length of the camera variable “.image.services.nuc.commit” followed by the ASCII representation of it, plus an additional byte of data (in this case 0x01) for the new BOOLEAN value.

Service Code	Class	Instance	Attribute	Data
0x33	0x70	0x01		1A 2E 69 6D 61 67 65 2E 73 65 72 76 69 63 65 73 2E 6E 75 63 2E 63 6F 6D 6D 69 74 01

**Example using Service Code 0x34:**

Goal: Read Focus Position Value

Explanation: Data field is filled with the length of the camera variable “.system.focus.position” followed by the ASCII representation of it.

Service Code	Class	Instance	Attribute	Data
0x34	0x70	0x01		16 2E 73 79 73 74 65 6D 2E 66 6F 63 75 73 2E 70 6F 73 69 74 69 6F 6E

**Example using Service Code 0x35:**

Goal: Write Focus Position Value to 125

Explanation: Data field is filled with the length of the camera variable “.system.focus.position” followed by the ASCII representation of it, plus 4 additional bytes of data (in this case 0x7D 0x00 0x00 0x00) for the new INT32 value. The new value should be passed in Little-Endian to match EtherNet/IP. This means that the bytes are placed in order from least significant to most significant.

Service Code	Class	Instance	Attribute	Data
0x35	0x70	0x01		16 2E 73 79 73 74 65 6D 2E 66 6F 63 75 73 2E 70 6F 73 69 74 69 6F 6E 7D 00 00 00

**Example using Service Code 0x36:**

Goal: Read Zoom Factor Value

Explanation: Data field is filled with the length of the camera variable “.image.zoom.zoomFactor” followed by the ASCII representation of it.

Service Code	Class	Instance	Attribute	Data
0x36	0x70	0x01		16 2E 69 6D 61 67 65 2E 7A 6F 6F 6D 2E 7A 6F 6F 6D 46 61 63 74 6F 72

**Example using Service Code 0x37:**

Goal: Write Focus Position Value to 8.0

Explanation: Data field is filled with the length of the camera variable “.image.zoom.zoomFactor” followed by the ASCII representation of it, plus 4 additional bytes of data (in this case 0x00 0x00 0x41) for the new REAL value. The new value should be passed in Little-Endian to match EtherNet/IP. This means that the bytes are placed in order from least significant to most significant.

Service Code	Class	Instance	Attribute	Data
0x37	0x70	0x01		16 2E 69 6D 61 67 65 2E 7A 6F 6F 6D 2E 7A 6F 6F 6D 46 61 63 74 6F 72 00 00 41

**Example using Service Code 0x38:**

Goal: Read Image Automatic Adjust Setting

Explanation: Data field is filled with the length of the camera variable “.image.contadj.adjMode” followed by the ASCII representation of it.

Service Code	Class	Instance	Attribute	Data
0x38	0x70	0x01		16 2E 69 6D 61 67 65 2E 63 6F 6E 74 61 64 6A 2E 61 64 6A 4D 6F 64 65

**Example using Service Code 0x39:**

Goal: Write Image Automatic Adjust Setting to “Auto”

Explanation: Data field is filled with the length of the camera variable “.image.contadj.adjMode” followed by the ASCII representation of it. The next byte of data is the size of the new ASCII string value to follow (in this case 0x04). Then, attach the new ASCII value (in this case “0x41 0x75 0x74 0x6F”).

Service Code	Class	Instance	Attribute	Data
0x39	0x70	0x01		16 2E 69 6D 61 67 65 2E 63 6F 6E 74 61 64 6A 2E 61 64 6A 4D 6F 64 65 04 41 75 74 6F

## Appendix A – Additional PCCC Mappings

EtherNet/IP Objects 0x64 through 0x6F are also available to access using PCCC.

### ***Additional Integer (N) mappings***

To access integer (N) mappings of Objects 0x64-0x6F use the following information:

1. The file number is the same as the decimal value of the EtherNet/IP Object number.
2. The file offset can be calculated using the following formula:  
**Beginning File Offset** = ((Instance# \* 4000) + (Attribute# - 1) \* 20) + 1
3. Each attribute is allocated a length of 20 for the value. You can read/write a maximum length of 20 at a time if the read or write begins from **Beginning File Offset**.
4. The first value of the length is reserved for the length (in bytes) for the data value.
5. If a value is writeable, then the new value will be displayed when read next, else there was an error.
6. If value is a DINT or REAL data type, then the following will happen:
  - a. Number of bytes will be in (**Beginning File Offset**)
  - b. Value in Little-Endian format will be in (**Beginning File Offset +1**) and (**Beginning File Offset +2**)
  - c. Number of bytes again will be in (**Beginning File Offset +3**)
  - d. Value in Big-Endian format will be in (**Beginning File Offset +4**) and (**Beginning File Offset +5**)
7. If a value is writeable and you are starting from **Beginning File Offset**, the length field is ONLY REQUIRED when changing a STRING data type.

Example reading Box 2 Min Temperature:

- File Number = 109
- Beginning File Offset = 8101
- Example Min Temperature is 302.25 Kelvin

N109:8101 = 4  
N109:8102 = 0x2000  
N109:8103 = 0x4397  
N109:8104 = 4  
N109:8105 = 0x4397  
N109:8106 = 0x2000

## ***Additional Float (F) mappings***

To access **Float (F)** mappings of Objects **0x64-0x6F** use the following information:

1. The file number can be calculated using the following formula:  
File Number = (Object# + 100)
2. The file offset can be calculated using the following formula:  
**Beginning File Offset** = ((Instance# \* 4000) + ((Attribute# - 1) \* 20) + 1)
3. Each attribute is allocated a length of 1 for the value. You will read/write the **Beginning File Offset** for a length of 1.
4. If a value is writeable, then the new value will be displayed when read next, else there was an error.
5. If the attribute is not a REAL or DINT value, then an error will appear.

Example reading Box 2 Min Temperature:

- File Number = 209
- Beginning File Offset = 8101
- Example Min Temperature is 302.25 Kelvin

F209:8101 = 302.25

## Appendix B – Modbus TCP Assembly Mappings

The EtherNet/IP assemblies are also available to access using Modbus TCP.

### Mapping 1 - Write Assembly Mapping

You must use Unit ID 1 to access.

This mapping gives you write access to some parameters over Modbus TCP.

Register 400XX	Data											Data Access					
	Bit 7	Bit 6	Bit 5	Bit 4	Bit 3	Bit 2	Bit 1	Bit 0	Bit 7	Bit 6	Bit 5		Bit 4	Bit 3	Bit 2	Bit 1	Bit 0
1	Reserved	Force Image One Shot	Save Image	One Time Image Auto Adjust	Auto Focus Fast	Auto Focus Full	Force NUC	Auto NUC	Reserved	Image Freeze	Image Live	Image Mode	Image Auto Adjust	Auto Focus Fast	Auto Focus Full	Force NUC	Auto NUC
	Reserved	Bit 14	Bit 13	Bit 12	Bit 11	Bit 10	Bit 9	Bit 8	Reserved	Bit 13	Bit 12	Bit 11	Bit 10	Bit 9	Bit 8	DO 1	DO 2
	Reserved	Image Mode	Image Live	Image Freeze	Reserved	Reserved	Reserved	DO 1	DO 2	Reserved	Reserved	Reserved	Reserved	Reserved	Reserved	Reserved	Reserved
2	Atmospheric Temp. Graphic	Reflected Temp. Graphic	Distance Graphic	Emissivity Graphic	Date/Time Graphic	Scale Graphic	Camera Label Graphic	Enable Overlay Graphics	Reserved	Reserved	Reserved	Reserved	Reserved	Reserved	Reserved	Reserved	Relative Humidity Graphic
	Reserved	Bit 14	Bit 13	Bit 12	Bit 11	Bit 10	Bit 9	Bit 8	Reserved	Reserved	Reserved	Reserved	Reserved	Reserved	Reserved	Reserved	Relative Humidity Graphic
	Reserved	Reserved	Reserved	Reserved	Reserved	Reserved	Reserved	Reserved	Reserved	Reserved	Reserved	Reserved	Reserved	Reserved	Reserved	Reserved	Reserved
3	Reserved	Reserved	Reserved	Reserved	Reserved	Reserved	Reserved	Reserved	Reserved	Reserved	Reserved	Reserved	Reserved	Reserved	Reserved	Reserved	Reserved
	Reserved	Bit 6	Bit 5	Bit 4	Bit 3	Bit 2	Bit 1	Bit 0	Reserved	Reserved	Reserved	Reserved	Reserved	Reserved	Reserved	Reserved	Reserved
	Reserved	Bit 14	Bit 13	Bit 12	Bit 11	Bit 10	Bit 9	Bit 8	Reserved	Reserved	Reserved	Reserved	Reserved	Reserved	Reserved	Reserved	Reserved
4	Reserved	Reserved	Reserved	Reserved	Reserved	Reserved	Reserved	Reserved	Reserved	Reserved	Reserved	Reserved	Reserved	Reserved	Reserved	Reserved	Reserved
	Reserved	Bit 6	Bit 5	Bit 4	Bit 3	Bit 2	Bit 1	Bit 0	Reserved	Reserved	Reserved	Reserved	Reserved	Reserved	Reserved	Reserved	Reserved
	Reserved	Bit 14	Bit 13	Bit 12	Bit 11	Bit 10	Bit 9	Bit 8	Reserved	Reserved	Reserved	Reserved	Reserved	Reserved	Reserved	Reserved	Reserved

### Mapping 2 - Read Assembly Values

You must use Unit ID 1 to access.

The Temperature values are mapped as a floating point value with the least significant word stored in the first register and the most significant word store in the second register. Registers 1001-1004 will be mapped in the same order as Mapping 3.

*Example:* Spot 1 temperature value of 302.25 will be mapped as follows:

Register 401019: 0x2000

Register 401020: 0x4397

Register 40XXXX	Data															Data Access
1001	Bit 7	Bit 6	Bit 5	Bit 4	Bit 3	Bit 2	Bit 1	Bit 0								Read Only
	Reserved	Force Image One Shot	Save Image	One Time Image Auto Adjust	Auto Focus Fast	Auto Focus Full	Force NUC	Auto NUC								
	Bit 15	Bit 14	Bit 13	Bit 12	Bit 11	Bit 10	Bit 9	Bit 8								
	Disable Alarm	Image Mode	Image Live	Image Freeze	DI 2	DI 1	DO 2	DO 1								
1002	Bit 7	Bit 6	Bit 5	Bit 4	Bit 3	Bit 2	Bit 1	Bit 0								Read Only
	Atmospheric Temp. Graphic	Reflected Temp. Graphic	Distance Graphic	Emissivity Graphic	Date/Time Graphic	Scale Graphic	Camera Label Graphic	Enable Overlay Graphics								
	Bit 15	Bit 14	Bit 13	Bit 12	Bit 11	Bit 10	Bit 9	Bit 8								
	Reserved	Reserved	Reserved	Reserved	Reserved	Measurement Mark Graphic	Lens Graphic	Relative Humidity Graphic								
1003	Bit 7	Bit 6	Bit 5	Bit 4	Bit 3	Bit 2	Bit 1	Bit 0								Read Only
	Alarm 8	Alarm 7	Alarm 6	Alarm 5	Alarm 4	Alarm 3	Alarm 2	Alarm 1								
	Bit 15	Bit 14	Bit 13	Bit 12	Bit 11	Bit 10	Bit 9	Bit 8								
	Set Configuration Preset (RESERVED FOR FUTURE USE)															
1004	Bit 7	Bit 6	Bit 5	Bit 4	Bit 3	Bit 2	Bit 1	Bit 0								Read Only
	Reserved	Reserved	Reserved	Reserved	Reserved	Reserved	Reserved	Reserved								
	Bit 15	Bit 14	Bit 13	Bit 12	Bit 11	Bit 10	Bit 9	Bit 8								
	Reserved	Reserved	Reserved	Reserved	Reserved	Reserved	Reserved	Reserved								
1005-1006	Delta Temperature 1															Read Only
1007-1008	Delta Temperature 2															Read Only
1009-1010	Delta Temperature 3															Read Only

FLIR Systems Object Model version 1.22

Register 40XXXX	Data	Data Access
1011-1012	Delta Temperature 4	Read Only
1013-1014	Delta Temperature 5	Read Only
1015-1016	Delta Temperature 6	Read Only
1017-1018	Internal Camera Temperature	Read Only
1019-1020	Spot 1 Temperature	Read Only
1021-1022	Box 1 Min Temperature	Read Only
1023-1024	Box 1 Max Temperature	Read Only
1025-1026	Box 1 Average Temperature	Read Only
1027	Spot 1 Temperature Valid State	Read Only
1028	Box 1 Min Temperature Valid State	Read Only
1029	Box 1 Max Temperature Valid State	Read Only
1030	Box 1 Avg Temperature Valid State	Read Only
1031-1032	Spot 2 Temperature	Read Only
1033-1034	Box 2 Min Temperature	Read Only
1035-1036	Box 2 Max Temperature	Read Only
1037-1038	Box 2 Average Temperature	Read Only
1039	Spot 2 Temperature Valid State	Read Only
1040	Box 2 Min Temperature Valid State	Read Only
1041	Box 2 Max Temperature Valid State	Read Only
1042	Box 2 Avg Temperature Valid State	Read Only
1043-1044	Spot 3 Temperature	Read Only
1045-1046	Box 3 Min Temperature	Read Only
1047-1048	Box 3 Max Temperature	Read Only
1049-1050	Box 3 Average Temperature	Read Only
1051	Spot 3 Temperature Valid State	Read Only
1052	Box 3 Min Temperature Valid State	Read Only
1053	Box 3 Max Temperature Valid State	Read Only
1054	Box 3 Avg Temperature Valid State	Read Only



FLIR Systems Object Model version 1.22

Register 40XXXX	Data	Data Access
1055-1056	Spot 4 Temperature	Read Only
1057-1058	Box 4 Min Temperature	Read Only
1059-1060	Box 4 Max Temperature	Read Only
1061-1062	Box 4 Average Temperature	Read Only
1063	Spot 4 Temperature Valid State	Read Only
1064	Box 4 Min Temperature Valid State	Read Only
1065	Box 4 Max Temperature Valid State	Read Only
1066	Box 4 Avg Temperature Valid State	Read Only
1067-1078	.....Spot 5/ Box 5.....	Read Only
1079-1090	.....Spot 6/ Box 6.....	Read Only
1091-1102	.....Spot 7/ Box 7.....	Read Only
1103-1114	.....Spot 8/ Box 8.....	Read Only
1115-1126	.....Spot 9/ Box 9.....	Read Only
1127-1138	.....Spot 10/ Box 10.....	Read Only
1139-1150	.....Spot 11/ Box 11.....	Read Only
1151-1162	.....Spot 12/ Box 12.....	Read Only
1163-1174	.....Spot 13/ Box 13.....	Read Only
1175-1186	.....Spot 14/ Box 14.....	Read Only
1187-1198	.....Spot 15/ Box 15.....	Read Only
1199-1210	.....Spot 16/ Box 16.....	Read Only
1211-1222	.....Spot 17/ Box 17.....	Read Only
1223-1234	.....Spot 18/ Box 18.....	Read Only
1235-1246	.....Spot 19/ Box 19.....	Read Only
1247-1258	.....Spot 20/ Box 20.....	Read Only

### Mapping 3 - Read Assembly Values

You must use Unit ID 1 to access.

The Temperature values are mapped as a floating point value with the most significant word stored in the first register and the least significant word store in the second register. Registers 2001-2004 will be mapped in the same order as Mapping 2.

*Example:* Spot 1 temperature value of 302.25 will be mapped as follows:

Register 402019: 0x4397  
 Register 402020: 0x2000

Register 40XXX	Data											Data Access	
2001	Bit 7	Bit 6	Bit 5	Bit 4	Bit 3	Bit 2	Bit 1	Bit 0					Read Only
	Reserved	Force Image One Shot	Save Image	One Time Image Auto Adjust	Auto Focus Fast	Auto Focus Full	Force NUC	Auto NUC					
	Bit 15	Bit 14	Bit 13	Bit 12	Bit 11	Bit 10	Bit 9	Bit 8					
	Disable Alarm	Image Mode	Image Live	Image Freeze	DI 1	DI 2	DO 1	DO 2	DO 1				
2002	Bit 7	Bit 6	Bit 5	Bit 4	Bit 3	Bit 2	Bit 1	Bit 0					Read Only
	Atmospheric Temp. Graphic	Reflected Temp. Graphic	Distance Graphic	Emissivity Graphic	Date/Time Graphic	Scale Graphic	Camera Label Graphic	Enable Overlay Graphics					
	Bit 15	Bit 14	Bit 13	Bit 12	Bit 11	Bit 10	Bit 9	Bit 8					
	Reserved	Reserved	Reserved	Reserved	Reserved	Measurement Mark Graphic	Lens Graphic	Relative Humidity Graphic					
2003	Bit 7	Bit 6	Bit 5	Bit 4	Bit 3	Bit 2	Bit 1	Bit 0					Read Only
	Alarm 8	Alarm 7	Alarm 6	Alarm 5	Alarm 4	Alarm 3	Alarm 2	Alarm 1					
	Bit 15	Bit 14	Bit 13	Bit 12	Bit 11	Bit 10	Bit 9	Bit 8					
									Set Configuration Preset (RESERVED FOR FUTURE USE)				
2004	Bit 7	Bit 6	Bit 5	Bit 4	Bit 3	Bit 2	Bit 1	Bit 0					Read Only
	Reserved	Reserved	Reserved	Reserved	Reserved	Reserved	Reserved	Reserved					
	Bit 15	Bit 14	Bit 13	Bit 12	Bit 11	Bit 10	Bit 9	Bit 8					
	Reserved	Reserved	Reserved	Reserved	Reserved	Reserved	Reserved	Reserved					
2005-2006	Delta Temperature 1											Read Only	
2007-2008	Delta Temperature 2											Read Only	
2009-2010	Delta Temperature 3											Read Only	

FLIR Systems Object Model version 1.22

<b>Register 40XXXX</b>	<b>Data</b>	<b>Data Access</b>
2011-2012	Delta Temperature 4	Read Only
2013-2014	Delta Temperature 5	Read Only
2015-2016	Delta Temperature 6	Read Only
2017-2018	Internal Camera Temperature	Read Only
2019-2020	Spot 1 Temperature	Read Only
2021-2022	Box 1 Min Temperature	Read Only
2023-2024	Box 1 Max Temperature	Read Only
2025-2026	Box 1 Average Temperature	Read Only
2027	Spot 1 Temperature Valid State	Read Only
2028	Box 1 Min Temperature Valid State	Read Only
2029	Box 1 Max Temperature Valid State	Read Only
2030	Box 1 Avg Temperature Valid State	Read Only
2031-2032	Spot 2 Temperature	Read Only
2033-2034	Box 2 Min Temperature	Read Only
2035-2036	Box 2 Max Temperature	Read Only
2037-2038	Box 2 Average Temperature	Read Only
2039	Spot 2 Temperature Valid State	Read Only
2040	Box 2 Min Temperature Valid State	Read Only
2041	Box 2 Max Temperature Valid State	Read Only
2042	Box 2 Avg Temperature Valid State	Read Only
2043-2044	Spot 3 Temperature	Read Only
2045-2046	Box 3 Min Temperature	Read Only
2047-2048	Box 3 Max Temperature	Read Only
2049-2050	Box 3 Average Temperature	Read Only
2051	Spot 3 Temperature Valid State	Read Only
2052	Box 3 Min Temperature Valid State	Read Only
2053	Box 3 Max Temperature Valid State	Read Only
2054	Box 3 Avg Temperature Valid State	Read Only

FLIR Systems Object Model version 1.22

<b>Register 40XXXX</b>	<b>Data</b>	<b>Data Access</b>
2055-2056	Spot 4 Temperature	Read Only
2057-2058	Box 4 Min Temperature	Read Only
2059-2060	Box 4 Max Temperature	Read Only
2061-2062	Box 4 Average Temperature	Read Only
2063	Spot 4 Temperature Valid State	Read Only
2064	Box 4 Min Temperature Valid State	Read Only
2065	Box 4 Max Temperature Valid State	Read Only
2066	Box 4 Avg Temperature Valid State	Read Only
2067-2078	.....Spot 5/ Box 5.....	Read Only
2079-2090	.....Spot 6/ Box 6.....	Read Only
2091-2102	.....Spot 7/ Box 7.....	Read Only
2103-2114	.....Spot 8/ Box 8.....	Read Only
2115-2126	.....Spot 9/ Box 9.....	Read Only
2127-2138	.....Spot 10/ Box 10.....	Read Only
2139-2150	.....Spot 11/ Box 11.....	Read Only
2151-2162	.....Spot 12/ Box 12.....	Read Only
2163-2174	.....Spot 13/ Box 13.....	Read Only
2175-2186	.....Spot 14/ Box 14.....	Read Only
2187-2198	.....Spot 15/ Box 15.....	Read Only
2199-2210	.....Spot 16/ Box 16.....	Read Only
2211-2222	.....Spot 17/ Box 17.....	Read Only
2223-2234	.....Spot 18/ Box 18.....	Read Only
2235-2246	.....Spot 19/ Box 19.....	Read Only
2247-2258	.....Spot 20/ Box 20.....	Read Only

## Appendix C – Additional Modbus TCP Mappings

EtherNet/IP Objects 0x64 through 0x6F are also available to access using Modbus TCP.

### *Additional Modbus mappings*

To access attributes in Objects 0x64-0x6F over Modbus TCP use the following information:

1. The Modbus Unit ID is the same as the decimal value of the EtherNet/IP Object number.
2. The starting register can be calculated using the following formula:  

$$\text{Starting Register} = ((\text{Instance\#} * 4000) + ((\text{Attribute\#} - 1) * 20) + 1)$$
3. Each attribute is allocated a 20 registers for the value. You can read/write a maximum length of 20 at a time if the read or write begins from **Starting Register**.
4. The first register of the 20 register range is reserved for the length (in bytes) of the data value. If the attribute is a REAL/DINT value, the size will be 4 bytes, BOOL is 1 byte, UINT is 2 bytes, and the STRING size is the number of characters in the string.
5. If a value is writeable, then the new value will be displayed when read next, else there was an error.
6. If value is a DINT or REAL data type, then the following will happen:
  - a. Number of bytes will be in (**Starting Register**)
  - b. Value in Little-Endian format will be in (**Starting Register +1**) and (**Starting Register +2**)
  - c. Number of bytes again will be in (**Starting Register +3**)
  - d. Value in Big-Endian format will be in (**Starting Register +4**) and (**Starting Register +5**)
7. If a value is writeable and you are starting from **Starting Register**, the length field is ONLY REQUIRED when changing a STRING data type.
8. Only these Modbus Function Codes are supported for these mappings:
  - o 4 Read Holding Registers
  - o 16 Write Multiple Holding Registers
  - o 23 Read/ Write Multiple Holding Registers
9. If the data type is STRING, two characters make up a single register.
10. When you perform a write, if the starting address of the write is the size register, DO write the size in bytes of the value in the first register followed by the actual value starting at the second register. If the starting address of the write is not the size register, DO NOT write the size, just write the new attribute value.
  - o Example: Execute a write of 25 to Box 1 Height.
    - Modbus Unit ID = 109
    - Modbus Range = 4361 – 4380

If you write the full 20 registers starting at 4361, then you must send the size of the data type in bytes in the first register then the data:

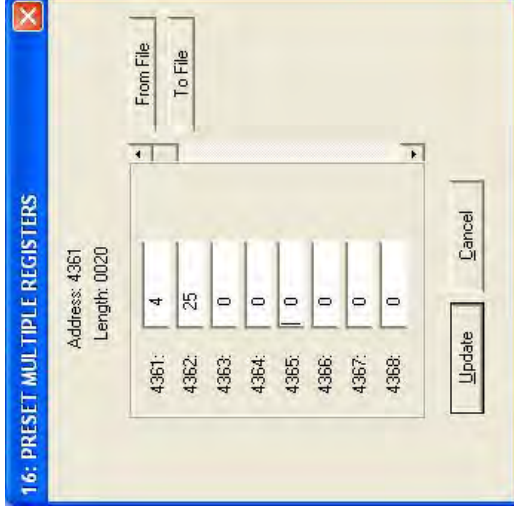

If you write every register but the first in the group, then there is no need to send the size in the request. You can just write the new values:

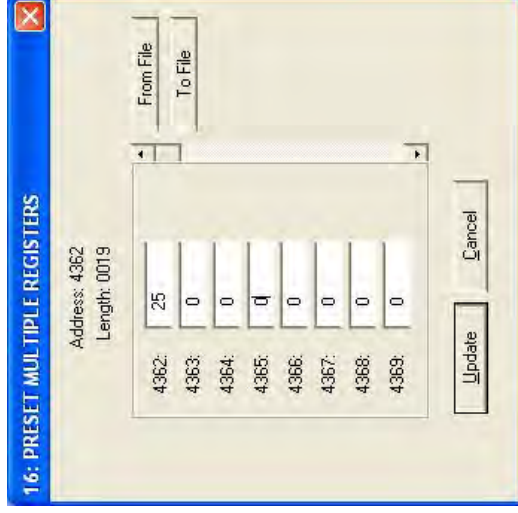

Example reading Box 2 Min Temperature:

- Modbus Unit ID (Slave ID) = 109
- Starting Register = Holding Register 8101
- Example Min Temperature is 302.25 Kelvin

8101 = 4

8102 = 0x2000

8103 = 0x4397

8104 = 4

8105 = 0x4397

8106 = 0x2000

---

**A note on the technical production of this publication**

This publication was produced using XML — the eXtensible Markup Language. For more information about XML, please visit <http://www.w3.org/XML/>

**A note on the typeface used in this publication**

This publication was typeset using Linotype Helvetica™ World. Helvetica™ was designed by Max Miedinger (1910–1980)

**LOEF (List Of Effective Files)**

T501103.xml; en-US; AJ; 37387; 2016-09-20  
T505552.xml; en-US; 9599; 2013-11-05  
T505013.xml; en-US; 35155; 2016-04-21  
T505802.xml; en-US; 18975; 2014-10-26  
T505929.xml; ; 37379; 2016-09-20  
T505470.xml; en-US; 12154; 2014-03-06  
T505007.xml; en-US; 35155; 2016-04-21  
T505004.xml; en-US; 35155; 2016-04-21  
T505000.xml; en-US; 35155; 2016-04-21  
T505005.xml; en-US; 35155; 2016-04-21  
T505001.xml; en-US; 32554; 2016-01-20  
T505006.xml; en-US; 32555; 2016-01-20  
T505002.xml; en-US; 33518; 2016-02-18







---

**Website**

<http://www.flir.com>

**Customer support**

<http://support.flir.com>

**Copyright**

© 2016, FLIR Systems, Inc. All rights reserved worldwide.

**Disclaimer**

Specifications subject to change without further notice. Models and accessories subject to regional market considerations. License procedures may apply. Products described herein may be subject to US Export Regulations. Please refer to [exportquestions@flir.com](mailto:exportquestions@flir.com) with any questions.

Publ. No.: T559913  
Release: AJ  
Commit: 37387  
Head: 37609  
Language: en-US  
Modified: 2016-09-20  
Formatted: 2016-10-04